

SOCKETS 3/8"

1000V



EGA Master insulated tools comply with IEC 60900 international standard, each one of the pieces being tested at 10,000V (10 times the voltage we certify). They are also tested rigorously according to what the norms establishes: adherence test, impact test, flame propagation test and dielectric penetration test.



MAIN APPLICATION FIELDS

Electrical installation	High Voltage networks	Electric maintenance
Power Plants	Low Voltage networks	Fire-fighters
Electric Stations and substations	Telecommunications	Lighting installation and repair

CAUTION

- 1 Don't ever use tools under voltage if they present pores, fissures, encrusted elements or if the white insulation layer is visible.
- 2 **Insulating floors and safety shoes** are recommended to work under voltage.
- 3 **Avoid contact with water** while working under voltage.
- 4 **Do not ever touch directly any item that may be under voltage.** Use a voltage tester to check first.

SOCKETS 3/8"

1000V

EGA Master offers a wide range of 1000V insulated sockets, both short range and long series offering in turn a large number of additional items, such as adapters, articulated handles, extensions, ratchets, etc.

There are ranges of 1/4 ", 3/8" and 1/2 "square driver for the most demanding professionals.



both in mm and inches

1. Sockets with 6 and 12 edges both in mm and in inches to suit user's needs.



2. Made of chrome-vanadium steel, designed to support high torques with minimum wear out, providing greater durability.

3. The **insulation** provides maximum adherence and safety against unforeseen circumstances.

4. Un-erasable laser marking.

SOCKET WRENCHES 3/8"

mm

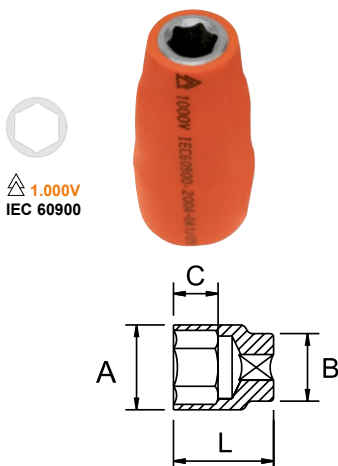

COD	AF	L mm	A	B	C	gr.	
74914	6mm	27	11	17	12	20	
74915	7mm		12				
74916	8mm		13				
74917	9mm		14				
74918	10mm		15				
74919	11mm		16				
74920	12mm	29	17	20	14	31	10
74921	13mm		18				
74922	14mm		20				
74923	15mm		22				
74924	16mm		23				
74925	17mm		24				
74926	18mm	31	21	22	16	45	
74927	19mm		26				
74928	20mm		28				
74929	21mm		24				
74930	22mm		30				
74997	23mm		26				
74998	24mm	32	28	18	70	75	

SOCKET WRENCHES 3/8"

mm

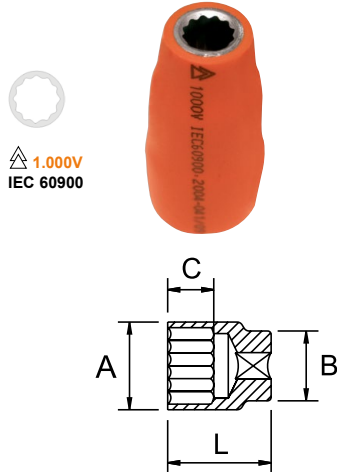

COD	AF	L mm	A	B	C	gr.		
73261	8mm	27	13	17	12	25		
73262	9mm		14			31		
73263	10mm		15			33		
73264	11mm		16			35		
73265	12mm		17			10	14	45
73266	13mm		18					
73267	14mm		20			16	18	50
73268	15mm		22					
73269	16mm		23			18	20	55
73270	17mm		24					
73271	18mm	29	26	24	18	65		
73272	19mm		22					
73273	20mm		24					
73274	21mm	31	28	26	18	65		
73275	22mm		30					

Inch.

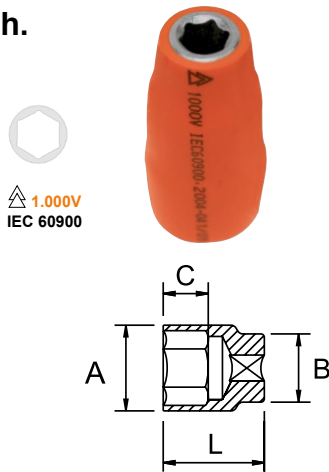

COD	AF	L mm	A	B	C	gr.		
74940	1/4"	27	12	17	12	25		
74941	9/32"		13			31		
74942	5/16"		14			33		
74943	11/32"		16			35		
74944	3/8"		17			10	14	45
74945	7/16"		18					
74946	1/2"		18			18	20	50
74947	9/16"		20					

Inch.

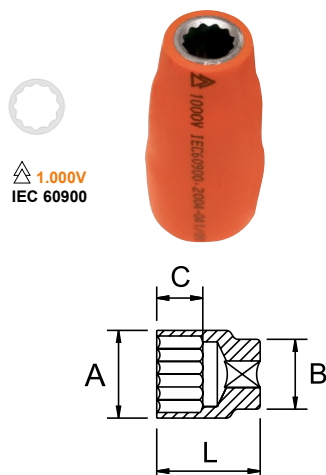

COD	AF	L mm	A	B	C	gr.		
73477	1/4"	27	12	17	12	25		
73478	5/16"		13			31		
73479	11/32"		14			33		
73480	3/8"		16			35		
73481	7/16"		17			10	14	45
73482	1/2"		18					
73483	9/16"		20			18	20	50
73484	19/32"		22					
73485	5/8"		22			19	14	35
73486	11/16"		24					
73487	3/4"	29	26	22	16	45		
73488	13/16"		28					
73489	7/8"		30				26	18

LONG SOCKET WRENCHES 3/8"

mm

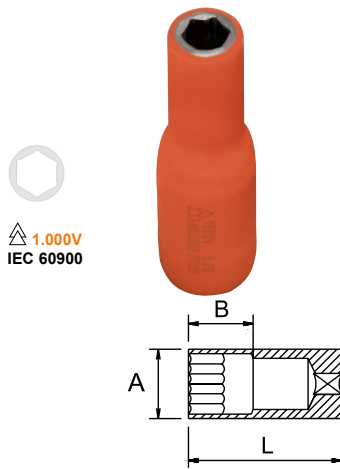

COD	AF	L mm	A	B	gr.	
75115	7mm	62	12	12	90	10
75116	8mm		13			
75117	9mm		14			
75118	10mm		15	14	95	
75119	11mm		16			
75120	12mm		18			
75121	13mm		20	18	105	
75122	14mm		22			
75123	15mm		24			
75124	16mm		27			
75125	17mm	29				
75126	18mm	31				
75127	19mm		20	185		
75129	21mm			210		
75130	22mm					

mm

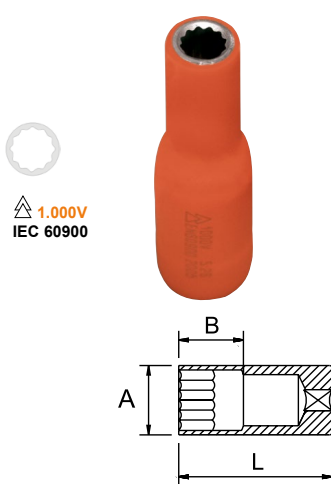

COD	AF	L mm	A	B	gr.	
75140	7mm	62	12	12	90	10
75141	8mm		13			
75142	9mm		14			
75143	10mm		15	14	95	
75144	11mm		16			
75145	12mm		18			
75146	13mm		20	18	105	
75147	14mm		23			
75148	15mm		25			
75149	16mm		27			
75150	17mm	29				
75151	18mm	31				
75152	19mm		20	185		
75153	20mm			210		
75154	21mm					
75155	22mm					

Inch.

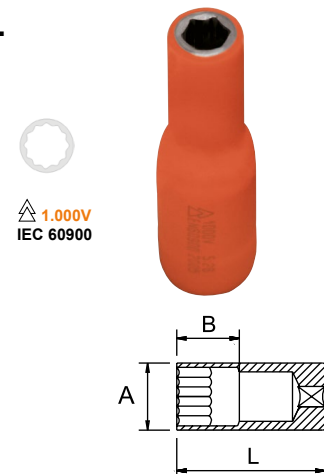

COD	AF	L mm	A	B	gr.	
75160	1/4"	62	11	12	90	10
75161	5/16"		13			
75162	3/8"		15			
75163	7/16"		17	14	95	
75164	1/2"		19			
75165	9/16"		21	18	105	
75166	19/32"		22			
75167	5/8"		24			
75168	11/16"		26			
75169	3/4"		28			
75170	13/16"	30				
75171	7/8"		20	185		
				210		

TECHNICAL SPECIFICATIONS

MATERIAL	Socket wrenches	Cr-V
	Isolation	PVC
MINIMUM HARDNESS	39 HRc	
FINISH	Isolated orange RAL 2009	

REVERSIBLE RATCHET HANDLE



COD					
73282	3/8"	200	320	6	1
COD					
73685	3/8"	200	390	6	1

EXTENSION



COD					
73276	3/8"	100	110	6	1
73280		125	112		
73281		250	290		

HEXAGONAL SOCKET



COD			
73290	3mm	42	10
73291	4mm	44	
73292	5mm	46	
73293	6mm	50	
73294	7mm	65	
73295	8mm	65	
73296	10mm	80	

T HANDLE



COD					
73283	3/8"	200	600	6	1

ADAPTER



COD				
73284	3/8"-1/2"	47	5	1



COD				
73285	3/8"-1/4"	65	5	1

SOCKET WRENCHES SETS 3/8"

8 Pcs.



COD		pcs.	Kg.
79071	51079	8	1,5

Pcs.	Description	Composition
1	Ratchet 1000V	73282 (3/8")
4	Sockets 1000V	8-10-13-17 mm (3/8")
2	Hexagonal sockets 1000V	4-5 mm (3/8")
1	Extension 1000V	73280 (3/8")

8 Pcs.



COD		pcs.	Kg.
79437	51079	8	1,5

Pcs.	Description	Composition
1	Ratchet 1000V	73282 (3/8")
4	Sockets 1000V	1/4"-5/16"-3/8"-1/2" (3/8")
2	Hexagonal sockets 1000V	4-5 mm (3/8")
1	Extension 1000V	73280 (3/8")

10 Pcs.

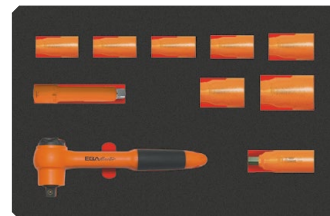

COD		pcs.	Kg.
79072	51053	10	2

Pcs.	Description	Composition
1	Ratchet 1000V	73282 (3/8")
7	Sockets 1000V	8-10-13-14-17-19-21 mm (3/8")
1	Hexagonal sockets 1000V	5 mm (3/8")
1	Extension 1000V	73280 (3/8")

SOCKET WRENCHES SETS 3/8"

10 Pcs.

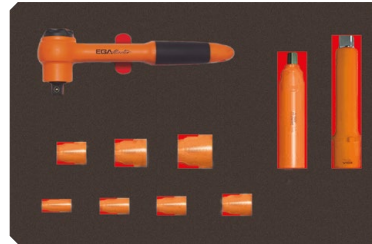

COD



pcs.



79477

51053

10

inch

2.5

Pcs.

Description

Composition

Pcs.	Description	Composition
1	Ratchet 1000V	73282 (3/8")
2	Extension 1000V	73276 / 73280 (3/8")
7	Sockets 1000V	3/8", 7/16", 1/2", 5/8", 11/16", 3/4", 13/16"

**11 Pcs.
 LONG
 SOCKETS**

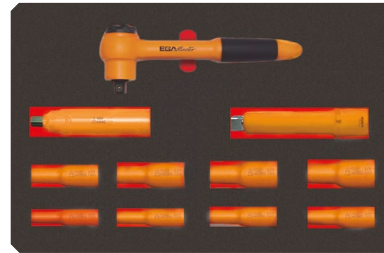

COD



pcs.



79478

51053

11

inch

2.8

Pcs.

Description

Composition

Pcs.	Description	Composition
1	Ratchet 1000V	73282 (3/8")
2	Extension 1000V	73276 / 73280 (3/8")
8	(L.S.) Sockets 1000V	3/8", 7/16", 1/2", 9/16", 5/8", 11/16", 3/4", 13/16"

**19 Pcs.
 LONG AND
 SHORT
 SOCKETS**



COD



pcs.



73015

51053

19

mm

3,3

Pcs.

Description



Composition

Pcs.	Description	Composition
1	Ratchet 1000V	73282 (3/8")
1	Extension 1000V	73280 (3/8")
1	T Handle 1000V	(3/8")
12	Sockets 1000V	6-7-8-9-10-11-12-13-14-17-19-21 mm (3/8")
1	(L.S.) Sockets 1000V	10 mm (3/8")
3	Hexagonal sockets 1000V	4-5-7 mm (3/8")

SOCKET WRENCHES SETS 3/8"

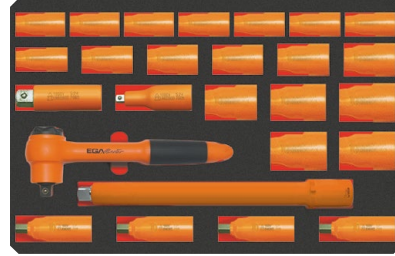
26 Pcs.



COD		pcs.	mm	Kg. 
79073	51053	26	mm	4,2

Pcs.	Description	Composition
1	Ratchet 1000V	73282 (3/8")
18	Sockets 1000V	6-7-8-9-10-11-12-13-14-16-17-18-19-20-21-22-23-24 mm (3/8")
4	Hexagonal sockets 1000V	4-5-6-8 mm (3/8")
1	Extension 1000V	73281 (3/8")
2	Adapter 1000V	3/8"-1/2" / 3/8"-1/4"