

## Ring cable lug - C-RC 50/M8 DIN - 3240111

Please be informed that the data shown in this PDF Document is generated from our Online Catalog. Please find the complete data in the user's documentation. Our General Terms of Use for Downloads are valid (<http://phoenixcontact.com/download>)



Ring cable lug, non-insulated, 50 mm², M8

### Your advantages

- ✓ The CRIMPFOX-RC... tools from our CRIMPFOX range of crimping pliers are available for optimum crimping
- ✓ The hard-soldered press zone enables maximum conductor pull-out values to be achieved
- ✓ The ring cable lugs without plastic sleeve are made from high-quality tin-plated electrolytic copper for maximum protection against corrosion

### Key Commercial Data

Packing unit	100 pc
Minimum order quantity	100 pc
GTIN	 4 046356 453288
GTIN	4046356453288

### Technical data

#### Dimensions

Length (b)	43 mm
Width (a)	18 mm
Maximum stripping length	19 mm
Length of insulation sleeve (c)	16 mm
Inner dimension of the insulating collar (d)	11 mm
Distance between the center and the insulation sleeve (e)	18 mm
Inner diameter (f)	8.4 mm
Material thickness (g)	1.8 mm

#### Ambient conditions

Ambient temperature (operation)	110 °C
---------------------------------	--------

#### General

# Ring cable lug - C-RC 50/M8 DIN - 3240111

## Technical data

### General

Color	silver
Stripping length	19 mm
Material	Copper
Coating	tin-plated

### Standards and Regulations

Design according to standard	DIN 46234
------------------------------	-----------

### Environmental Product Compliance

China RoHS	Environmentally friendly use period: unlimited = EFUP-e
	No hazardous substances above threshold values

## Drawings

Dimensional drawing

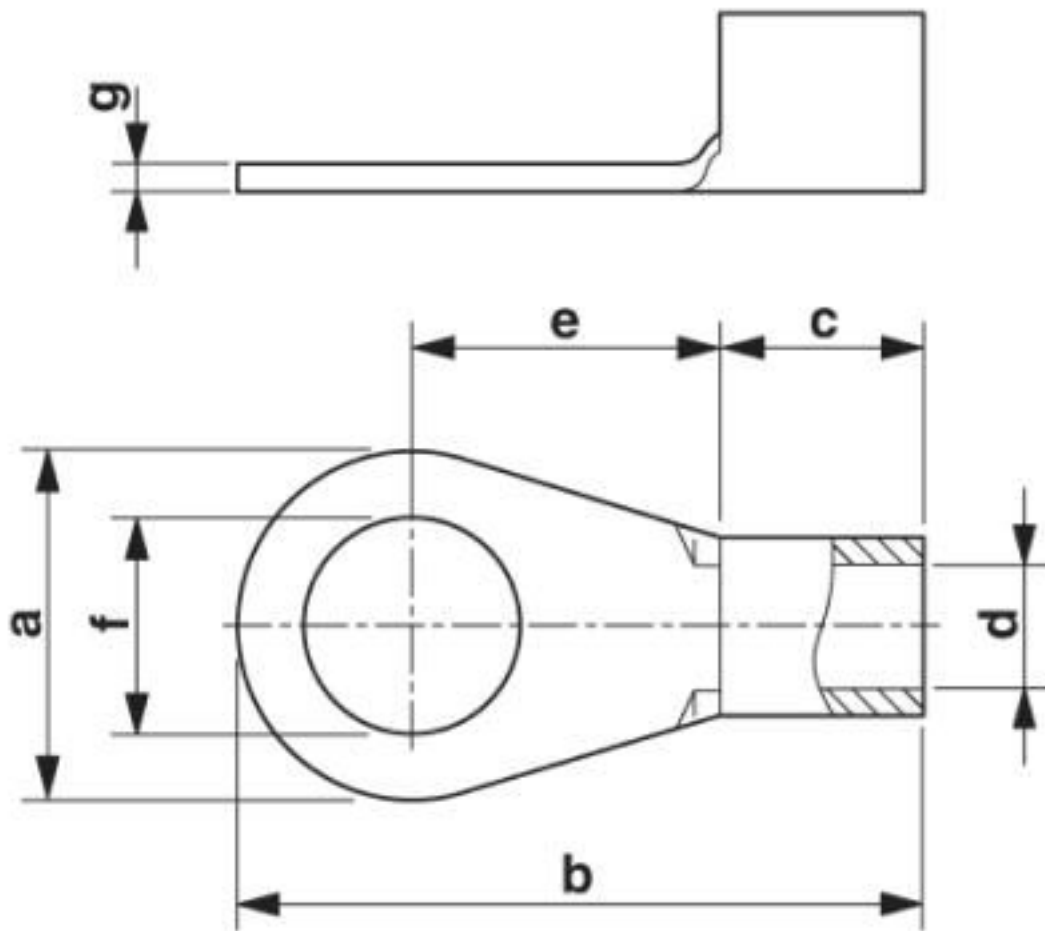

# Ring cable lug - C-RC 50/M8 DIN - 3240111

## Classifications

### eCl@ss

eCl@ss 10.0.1	27400204
eCl@ss 4.0	27060700
eCl@ss 4.1	27060700
eCl@ss 5.0	27400200
eCl@ss 5.1	27400200
eCl@ss 6.0	27400200
eCl@ss 7.0	27400203
eCl@ss 8.0	27400204
eCl@ss 9.0	27400204

### ETIM

ETIM 2.0	EC000005
ETIM 3.0	EC000005
ETIM 4.0	EC001052
ETIM 5.0	EC001052
ETIM 6.0	EC001052
ETIM 7.0	EC001052

### UNSPSC

UNSPSC 6.01	30211923
UNSPSC 7.0901	27121703
UNSPSC 11	27121703
UNSPSC 12.01	27121703
UNSPSC 13.2	27121707
UNSPSC 18.0	27121707
UNSPSC 19.0	27121707
UNSPSC 20.0	27121707
UNSPSC 21.0	27121707

## Approvals

### Approvals

---

Approvals

EAC

---

Ex Approvals

---

### Approval details

## Ring cable lug - C-RC 50/M8 DIN - 3240111

### Approvals

EAC



EAC-Zulassung

Phoenix Contact 2020 © - all rights reserved  
<http://www.phoenixcontact.com>

PHOENIX CONTACT GmbH & Co. KG  
Flachsmarktstr. 8  
32825 Blomberg  
Germany  
Tel. +49 5235 300  
Fax +49 5235 3 41200  
<http://www.phoenixcontact.com>

# Mouser Electronics

Authorized Distributor

Click to View Pricing, Inventory, Delivery & Lifecycle Information:

[Phoenix Contact:](#)

[3240111](#)