

Ferrule - AI 1,5 -10 BK - 3200195

Please be informed that the data shown in this PDF Document is generated from our Online Catalog. Please find the complete data in the user's documentation. Our General Terms of Use for Downloads are valid (<http://phoenixcontact.com/download>)



Ferrule, sleeve length: 10 mm, length: 16 mm, color: black

Your advantages

- The insulation reliability of close connections is increased and the splicing of wires is prevented
- The ferrules with plastic sleeve are made from soft tin-plated electrolytic copper

Key Commercial Data

Packing unit	100 pc
Minimum order quantity	100 pc
GTIN	 4 017918 093846
GTIN	4017918093846
Sales Key	05

Technical data

Dimensions

Length (b)	16 mm
Maximum stripping length	13 mm
Sleeve length	10 mm
Inner dimension of the insulating collar (d)	3.4 mm
Ferrule diameter	1.7 mm
Insulating collar thickness	0.3 mm
Sleeve wall thickness	0.15 mm

Ambient conditions

Short-term temperature	120 °C
Max. permanent temperature	105 °C (-40°C no load / 0°C dynamic load)

General

Ferrule - Al 1,5 -10 BK - 3200195

Technical data

General

Color	black
Components	free from silicone and halogen
Flammability rating according to UL 94	HB
Material	CU-DHP
Coating	tin-plated (galvanic)
Conductor category	Stranded conductors, class 2, 5, 6 / B, C, K, M

Standards and Regulations

Connection in acc. with standard	CSA
Flammability rating according to UL 94	HB
Design according to standard	DIN 46228-4:2017-05

Environmental Product Compliance

China RoHS	Environmentally friendly use period: unlimited = EFUP-e
	No hazardous substances above threshold values

Drawings

Dimensional drawing

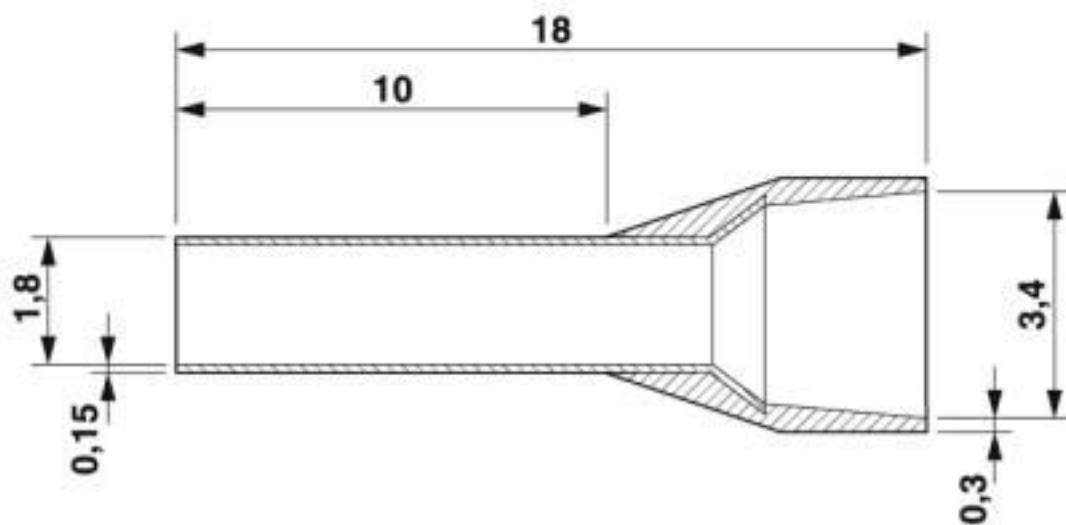

Classifications

eCl@ss

eCl@ss 10.0.1	27400201
eCl@ss 4.0	27060700
eCl@ss 4.1	27060700
eCl@ss 5.0	27400200
eCl@ss 5.1	27400200

Ferrule - AI 1,5 -10 BK - 3200195

Classifications

eCl@ss

eCl@ss 6.0	27400200
eCl@ss 7.0	27400201
eCl@ss 8.0	27400201
eCl@ss 9.0	27400201

ETIM

ETIM 2.0	EC000005
ETIM 3.0	EC000005
ETIM 4.0	EC000005
ETIM 5.0	EC000005
ETIM 6.0	EC000005
ETIM 7.0	EC000005

UNSPSC

UNSPSC 6.01	30212109
UNSPSC 7.0901	27121703
UNSPSC 11	27121703
UNSPSC 12.01	27121703
UNSPSC 13.2	27121703
UNSPSC 18.0	27121703
UNSPSC 19.0	27121703
UNSPSC 20.0	27121703
UNSPSC 21.0	27121703

Approvals

Approvals

Approvals

CSA / UL Listed / cUL Listed / CSAus / cULus Listed / cCSAus





Ex Approvals

Approval details

CSA		http://www.csagroup.org/services-industries/product-listing/	247397
-----	--	---	--------

Ferrule - AI 1,5 -10 BK - 3200195

Approvals

UL Listed		http://database.ul.com/cgi-bin/XYV/template/LISEXT/1FRAME/index.htm	E488001
cUL Listed		http://database.ul.com/cgi-bin/XYV/template/LISEXT/1FRAME/index.htm	E488001
CSAus		http://www.csagroup.org/services-industries/product-listing/	247397
cULus Listed			
cCSAus			

Phoenix Contact 2020 © - all rights reserved
<http://www.phoenixcontact.com>

PHOENIX CONTACT GmbH & Co. KG
Flachsmarktstr. 8
32825 Blomberg
Germany
Tel. +49 5235 300
Fax +49 5235 3 41200
<http://www.phoenixcontact.com>

Mouser Electronics

Authorized Distributor

Click to View Pricing, Inventory, Delivery & Lifecycle Information:

[Phoenix Contact:](#)

[3200195](#)