

# Single relay - REL-MR- 60DC/21 - 2961118

Please be informed that the data shown in this PDF Document is generated from our Online Catalog. Please find the complete data in the user's documentation. Our General Terms of Use for Downloads are valid (<http://phoenixcontact.com/download>)

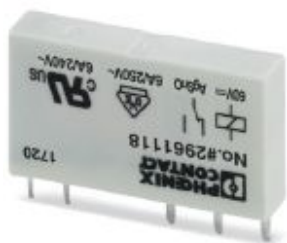

Plug-in miniature power relay, with power contact, 1 PDT, input voltage 60 V DC

## Your advantages

- Safe isolation according to DIN EN 50178 between coil and contact
- High degree of protection up to RT III depending on type (wash-proof)
- Power contacts up to 6 A



## Key Commercial Data

Packing unit	10 pc
Minimum order quantity	10 pc
GTIN	 4 017918 130886
GTIN	4017918130886
Sales Key	08

## Technical data

### Dimensions

Width	5 mm
Height	28 mm
Depth	15 mm

### Ambient conditions

Ambient temperature (operation)	-40 °C ... 85 °C
Ambient temperature (storage/transport)	-40 °C ... 85 °C
Degree of protection	RT III

### Coil side

Nominal input voltage $U_N$	60 V DC
Typical input current at $U_N$	3 mA

# Single relay - REL-MR- 60DC/21 - 2961118

## Technical data

### Coil side

Typical response time	5 ms
Typical release time	2.5 ms
Coil resistance	20500 Ω ±15 % (at 20 °C)
Power dissipation for nominal condition	0.18 W

### Contact side

Contact type	1 PDT
Type of switch contact	Single contact
Contact material	AgSnO
Maximum switching voltage	250 V AC/DC
Minimum switching voltage	5 V (at 100 mA)
Min. switching current	10 mA (at 12 V)
Maximum inrush current	10 A (4 s)
Limiting continuous current	6 A
Interrupting rating (ohmic load) max.	140 W (at 24 V DC)
	20 W (at 48 V DC)
	18 W (at 60 V DC)
	23 W (at 110 V DC)
	40 W (at 220 V DC)
	1500 VA (for 250 V AC)
Switching capacity	2 A (at 24 V, DC13)
	0.2 A (at 110 V, DC13)
	0.1 A (at 220 V, DC13)
	3 A (at 24 V, AC15)
	3 A (at 120 V, AC15)
	3 A (at 230 V, AC15)
Motor load according to UL 508	1/4 HP, 240 - 277 V AC (N/O contact)
	1/6 HP, 240 - 277 V AC (N/C contact)

### General

Test voltage relay winding/relay contact	4 kV AC (50 Hz, 1 min.)
Operating mode	100% operating factor
Mechanical service life	2x 10 <sup>7</sup> cycles
Mounting position	any
Assembly instructions	In rows with zero spacing

### Connection data

Connection method	Solder connection
-------------------	-------------------

### Standards and Regulations

Connection in acc. with standard	CUL
Standards/regulations	IEC 60664
	EN 50178

# Single relay - REL-MR- 60DC/21 - 2961118

## Technical data

### Standards and Regulations

	EN 61810-1
Pollution degree	3
Overvoltage category	III

### Environmental Product Compliance

China RoHS	Environmentally friendly use period: unlimited = EFUP-e
	No hazardous substances above threshold values

## Drawings

Drilling diagram

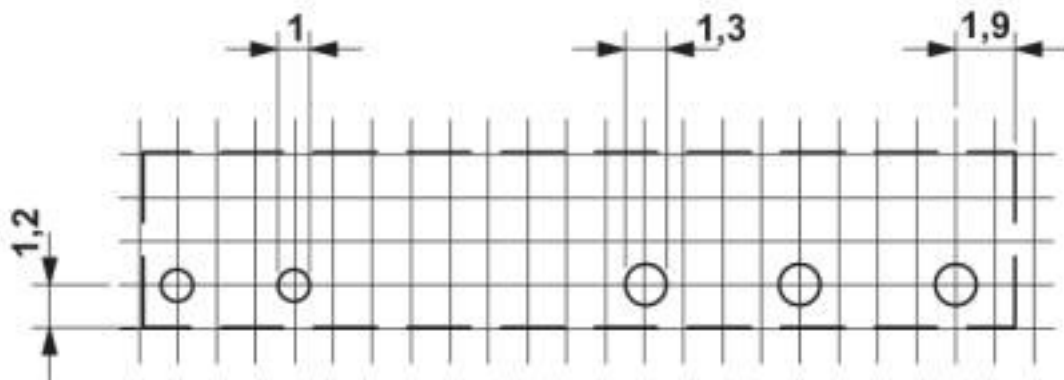

a = pitch division 1.25 mm and 1.27 mm

# Single relay - REL-MR- 60DC/21 - 2961118

Diagram

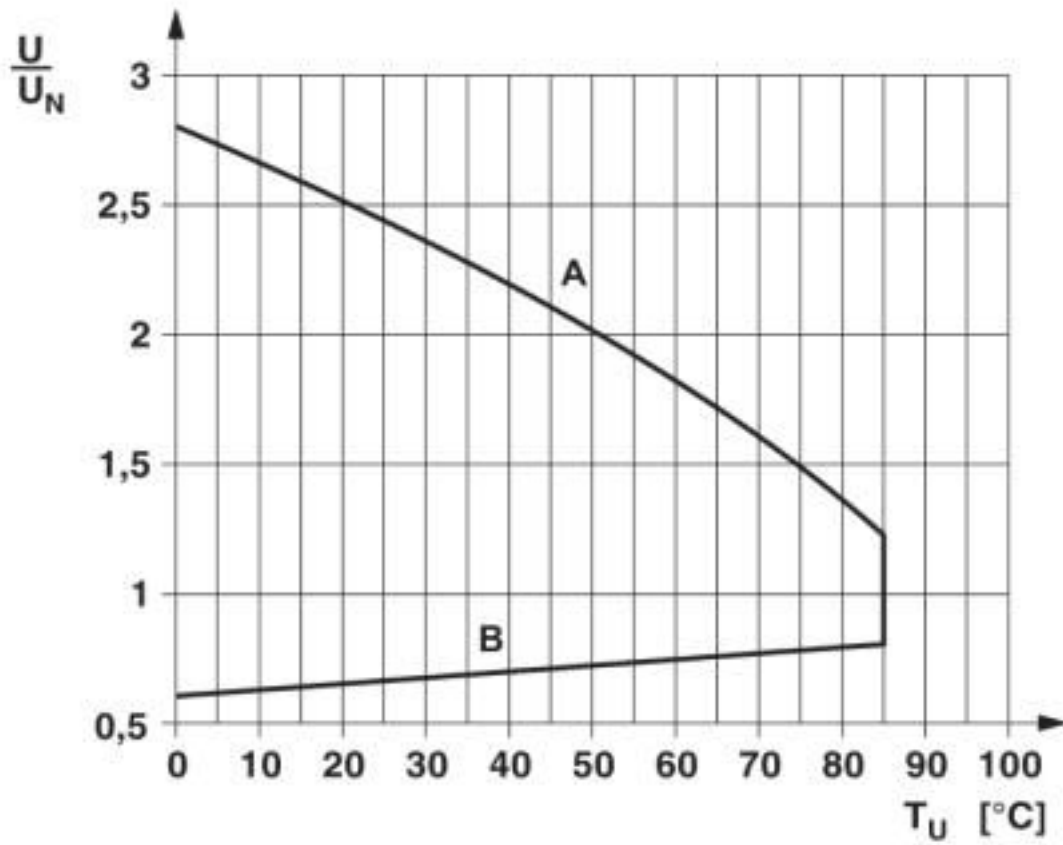

# Single relay - REL-MR- 60DC/21 - 2961118

Diagram

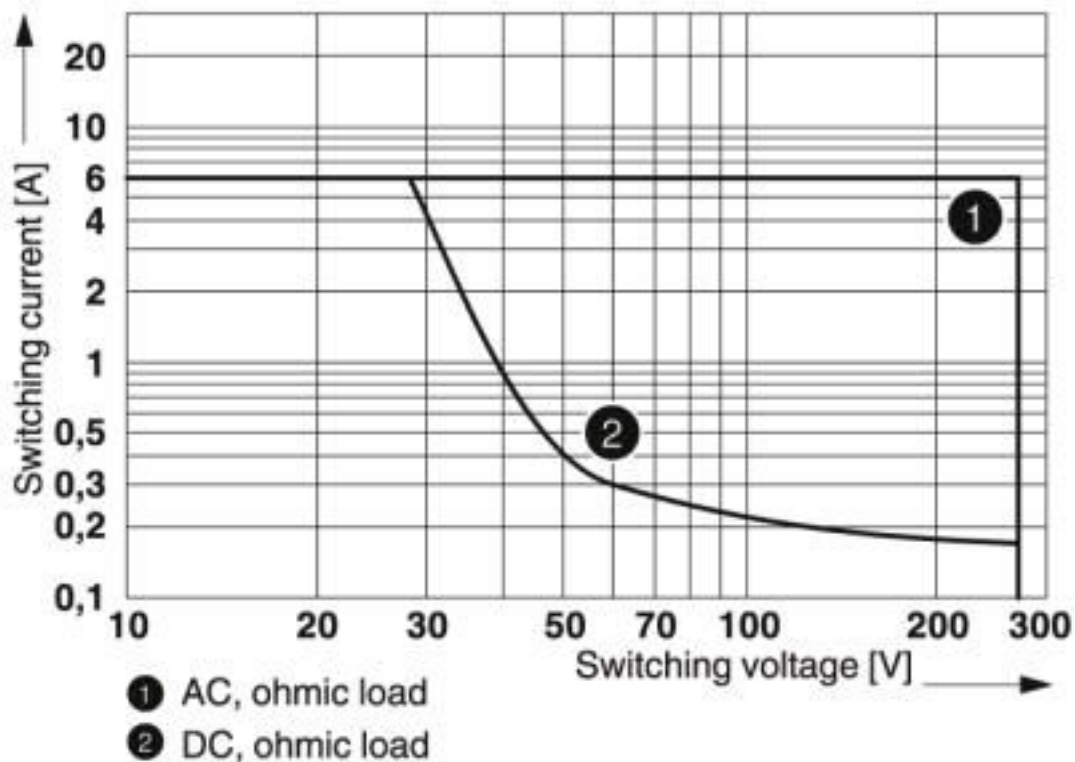

## Interrupting rating

Dimensional drawing

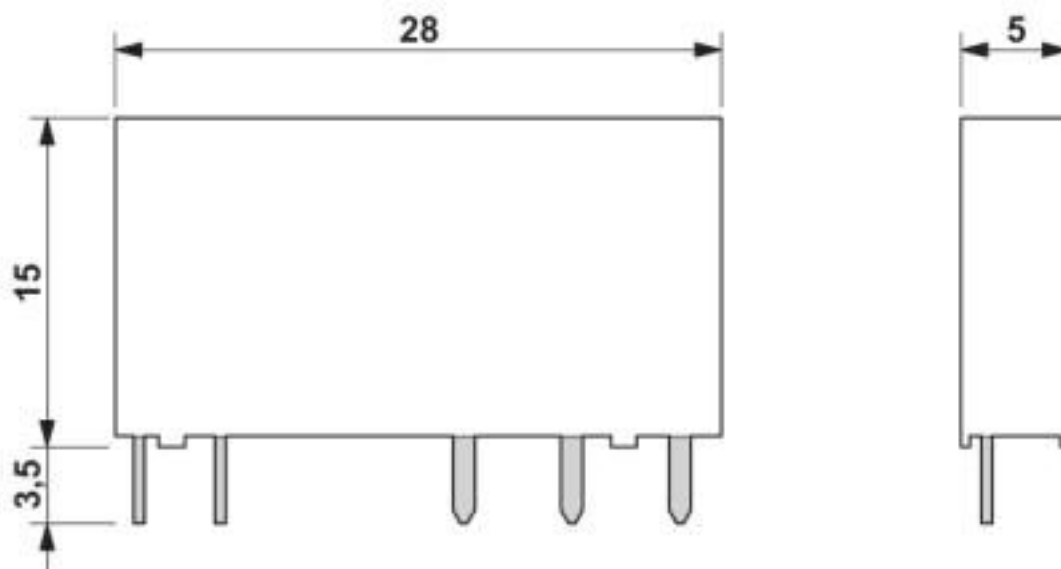

# Single relay - REL-MR- 60DC/21 - 2961118

Circuit diagram

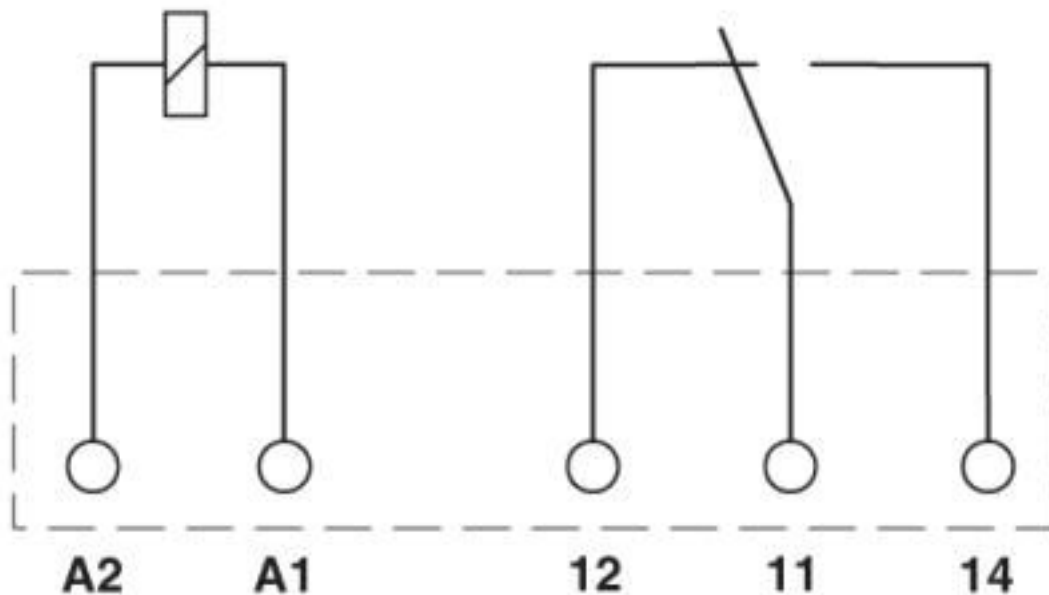

## Classifications

### eCl@ss

eCl@ss 10.0.1	27371601
eCl@ss 4.0	27371100
eCl@ss 4.1	27371100
eCl@ss 5.0	27371600
eCl@ss 5.1	27371600
eCl@ss 6.0	27371600
eCl@ss 7.0	27371601
eCl@ss 8.0	27371601
eCl@ss 9.0	27371601

### ETIM

ETIM 2.0	EC001437
ETIM 3.0	EC001437
ETIM 4.0	EC001437
ETIM 5.0	EC001437
ETIM 6.0	EC001437
ETIM 7.0	EC001437

### UNSPSC

UNSPSC 6.01	30211916
UNSPSC 7.0901	39121515
UNSPSC 11	39121515
UNSPSC 12.01	39121515

# Single relay - REL-MR- 60DC/21 - 2961118

## Classifications

### UNSPSC

UNSPSC 13.2	39122334
UNSPSC 18.0	39122334
UNSPSC 19.0	39122334
UNSPSC 20.0	39122334
UNSPSC 21.0	39122334

## Approvals

### Approvals

#### Approvals

PRS / EAC / EAC / UL Recognized / UL Recognized / cUL Recognized / cUL Recognized / VDE Zeichengenehmigung / VDE Zeichengenehmigung

#### Ex Approvals

### Approval details

PRS		<a href="http://www.prs.pl/">http://www.prs.pl/</a>	TE/2109/880590/16
-----	--	---	-------------------

EAC			TR_TS_D_00573_c
-----	--	--	-----------------

EAC			RU*C- DE.*08.B.00010
-----	--	--	-------------------------

UL Recognized		<a href="http://database.ul.com/cgi-bin/XYV/template/LISEXT/1FRAME/index.htm">http://database.ul.com/cgi-bin/XYV/template/LISEXT/1FRAME/index.htm</a>	FILE E 172140
---------------	--	---	---------------

UL Recognized		<a href="http://database.ul.com/cgi-bin/XYV/template/LISEXT/1FRAME/index.htm">http://database.ul.com/cgi-bin/XYV/template/LISEXT/1FRAME/index.htm</a>	FILE E 172140
---------------	--	---	---------------

cUL Recognized		<a href="http://database.ul.com/cgi-bin/XYV/template/LISEXT/1FRAME/index.htm">http://database.ul.com/cgi-bin/XYV/template/LISEXT/1FRAME/index.htm</a>	FILE E 172140
----------------	--	---	---------------

# Single relay - REL-MR- 60DC/21 - 2961118

## Approvals

cUL Recognized		<a href="http://database.ul.com/cgi-bin/XYV/template/LISEXT/1FRAME/index.htm">http://database.ul.com/cgi-bin/XYV/template/LISEXT/1FRAME/index.htm</a>	FILE E 172140
----------------	--	---	---------------

VDE Zeichengenehmigung		<a href="http://www2.vde.com/de/Institut/Online-Service/VDE-gepruefteProdukte/Seiten/Online-Suche.aspx">http://www2.vde.com/de/Institut/Online-Service/VDE-gepruefteProdukte/Seiten/Online-Suche.aspx</a>	40010212
------------------------	--	---	----------

VDE Zeichengenehmigung		<a href="http://www2.vde.com/de/Institut/Online-Service/VDE-gepruefteProdukte/Seiten/Online-Suche.aspx">http://www2.vde.com/de/Institut/Online-Service/VDE-gepruefteProdukte/Seiten/Online-Suche.aspx</a>	40032864
------------------------	--	---	----------

## Accessories

### Additional products

Relay base - PLC-BPT- 60DC/21 - 2900279



6.2 mm PLC basic terminal block with push-in connection, without relay or solid-state relay, for mounting on DIN rail NS 35/7,5, 1 PDT, input voltage 60 V DC

Relay base - PLC-BSP- 60DC/21 - 2967332



6.2 mm PLC basic terminal block with spring-cage connection, without relay or solid-state relay, for mounting on DIN rail NS 35/7,5, 1 PDT, input voltage 60 V DC

Relay base - PLC-BSC- 60DC/21 - 2966100



6.2 mm PLC basic terminal block with screw connection, without relay or solid-state relay, for mounting on DIN rail NS 35/7,5, 1 PDT, input voltage 60 V DC



## Single relay - REL-MR- 60DC/21 - 2961118

### Accessories

#### Relay base - PLC-BPT-120UC/21 - 2900280



6.2 mm PLC basic terminal block with push-in connection, without relay or solid-state relay, for mounting on DIN rail NS 35/7,5, 1 PDT, input voltage 120 V AC/DC

---

#### Relay base - PLC-BSP-120UC/21 - 2967167



6.2 mm PLC basic terminal block with spring-cage connection, without relay or solid-state relay, for mounting on DIN rail NS 35/7,5, 1 PDT, input voltage 120 V AC/DC

---

#### Relay base - PLC-BSC-120UC/21 - 2966032



6.2 mm PLC basic terminal block with screw connection, without relay or solid-state relay, for mounting on DIN rail NS 35/7,5, 1 PDT, input voltage 120 V AC/DC

---

#### Relay base - PLC-BSC-125DC/21 - 2980018



6.2 mm PLC basic terminal block with screw connection, without relay or solid-state relay, for mounting on DIN rail NS 35/7,5, 1 PDT, input voltage 125 V DC

---

#### Relay base - PLC-BPT-230UC/21 - 2900281



6.2 mm PLC basic terminal block with push-in connection, without relay or solid-state relay, for mounting on DIN rail NS 35/7,5, 1 PDT, input voltage 230 V AC/DC

## Single relay - REL-MR- 60DC/21 - 2961118

### Accessories

#### Relay base - PLC-BSP-230UC/21 - 2967183



6.2 mm PLC basic terminal block with spring-cage connection, without relay or solid-state relay, for mounting on DIN rail NS 35/7,5, 1 PDT, input voltage 230 V AC/DC

---

#### Relay base - PLC-BSC-230UC/21 - 2966045



6.2 mm PLC basic terminal block with screw connection, without relay or solid-state relay, for mounting on DIN rail NS 35/7,5, 1 PDT, input voltage 230 V AC/DC

---

#### Relay base - PLC-BPT-120UC/ 1/SEN - 2900451



6.2 mm PLC basic terminal block for input functions with push-in connection, without relay or solid-state relay, for mounting on DIN rail NS 35/7,5, with sensor supply voltage distribution (BB), 1 N/O contact, input voltage 120 V AC/DC

---

#### Relay base - PLC-BSP-120UC/ 1/SEN - 2967154



6.2 mm PLC basic terminal block for input functions with spring-cage connection, without relay or solid-state relay, for mounting on DIN rail NS 35/7,5, with sensor supply voltage distribution (BB), 1 N/O contact, input voltage 120 V AC/DC

---

#### Relay base - PLC-BSC-120UC/ 1/SEN - 2966074



6.2 mm PLC basic terminal block for input functions with screw connection, without relay or solid-state relay, for mounting on DIN rail NS 35/7,5, with sensor supply voltage distribution (BB), 1 N/O contact, input voltage 120 V AC/DC

---

## Single relay - REL-MR- 60DC/21 - 2961118

### Accessories

Relay base - PLC-BPT-230UC/ 1/SEN - 2900452



6.2 mm PLC basic terminal block for input functions with push-in connection, without relay or solid-state relay, for mounting on DIN rail NS 35/7,5, with sensor supply voltage distribution (BB), 1 N/O contact, input voltage 230 V AC/ DC

---

Relay base - PLC-BSP-230UC/ 1/SEN - 2967170



6.2 mm PLC basic terminal block for input functions with spring-cage connection, without relay or solid-state relay, for mounting on DIN rail NS 35/7,5, with sensor supply voltage distribution (BB), 1 N/O contact, input voltage 230 V AC/ DC

---

Relay base - PLC-BSC-230UC/ 1/SEN - 2966087



6.2 mm PLC basic terminal block for input functions with screw connection, without relay or solid-state relay, for mounting on NS 35/7,5 DIN rail, with sensor supply voltage distribution (BB), 1 N/O contact, input voltage: 230 V AC/ DC

---

Relay base - PLC-BPT-120UC/21/SO46 - 2900453



6.2 mm PLC basic terminal block with interference current and interference voltage protection on the control side, with push-in connection, without relay or solid-state relay, for mounting on DIN rail NS 35/7,5, with integrated RCZ filter, 1 PDT, input voltage 120 V AC

---

Relay base - PLC-BSP-120UC/21/SO46 - 2980351



6.2 mm PLC basic terminal block with interference current and interference voltage protection on the control side, with spring-cage connection, without relay or solid-state relay, for mounting on DIN rail NS 35/7,5, with integrated RCZ filter, 1 PDT, input voltage 120 V AC

---

## Single relay - REL-MR- 60DC/21 - 2961118

### Accessories

#### Relay base - PLC-BSC-120UC/21/SO46 - 2980319



6.2 mm PLC basic terminal block with interference current and interference voltage protection on the control side, with screw connection, without relay or solid-state relay, for mounting on DIN rail NS 35/7,5, with integrated RCZ filter, 1 PDT, input voltage 120 V AC

#### Relay base - PLC-BPT-230UC/21/SO46 - 2900455



6.2 mm PLC basic terminal block with interference current and interference voltage protection on the control side, with push-in connection, without relay or solid-state relay, for mounting on DIN rail NS 35/7,5, with integrated RCZ filter, 1 PDT, input voltage 230 V AC

#### Relay base - PLC-BSP-230UC/21/SO46 - 2980377



6.2 mm PLC basic terminal block with interference current and interference voltage protection on the control side, with spring-cage connection, without relay or solid-state relay, for mounting on DIN rail NS 35/7,5, with integrated RCZ filter, 1 PDT, input voltage 230 V AC

#### Relay base - PLC-BSC-230UC/21/SO46 - 2980335



6.2 mm PLC basic terminal block with interference current and interference voltage protection on the control side, with screw connection, without relay or solid-state relay, for mounting on DIN rail NS 35/7,5, with integrated RCZ filter, 1 PDT, input voltage 230 V AC

#### Relay base - PLC-BPT-120UC/ 1/SEN/SO46 - 2900456



6.2 mm PLC basic terminal block with interference current and interference voltage protection on the control side, with push-in connection, without relay or solid-state relay, with sensor supply voltage distribution (BB), 1 N/O contact, input voltage 120 V AC

## Single relay - REL-MR- 60DC/21 - 2961118

### Accessories

Relay base - PLC-BSP-120UC/ 1/SEN/SO46 - 2980364



6.2 mm PLC basic terminal block with interference current and interference voltage protection on the control side, with spring-cage connection, without relay or solid-state relay, with sensor supply voltage distribution (BB), 1 N/O contact, input voltage 120 V AC

---

Relay base - PLC-BSC-120UC/ 1/SEN/SO46 - 2980322



6.2 mm PLC basic terminal block with interference current and interference voltage protection on the control side, with screw connection, without relay or solid-state relay, with sensor supply voltage distribution (BB), 1 N/O contact, input voltage 120 V AC

---

Relay base - PLC-BPT-230UC/ 1/SEN/SO46 - 2900457



6.2 mm PLC basic terminal block with interference current and interference voltage protection on the control side, with push-in connection, without relay or solid-state relay, with sensor supply voltage distribution (BB), 1 N/O contact, input voltage 230 V AC

---

Relay base - PLC-BSP-230UC/ 1/SEN/SO46 - 2980380



6.2 mm PLC basic terminal block with interference current and interference voltage protection on the control side, with spring-cage connection, without relay or solid-state relay, with sensor supply voltage distribution (BB), 1 N/O contact, input voltage 230 V AC

---

Relay base - PLC-BSC-230UC/ 1/SEN/SO46 - 2980348



6.2 mm PLC basic terminal block with interference current and interference voltage protection on the control side, with screw connection, without relay or solid-state relay, with sensor supply voltage distribution (BB), 1 N/O contact, input voltage 230 V AC

---

Relay base - PLC-BSC-230UC/ 2/SEN - 2966456

---

---

Phoenix Contact 2020 © - all rights reserved  
<http://www.phoenixcontact.com>

PHOENIX CONTACT GmbH & Co. KG  
Flachmarktstr. 8  
32825 Blomberg  
Germany  
Tel. +49 5235 300  
Fax +49 5235 3 41200  
<http://www.phoenixcontact.com>

# Mouser Electronics

Authorized Distributor

Click to View Pricing, Inventory, Delivery & Lifecycle Information:

[Phoenix Contact:](#)

[2961118](#)