

FO converters - PSI-MOS-PROFIB/FO1300 E - 2708559

Please be informed that the data shown in this PDF Document is generated from our Online Catalog. Please find the complete data in the user's documentation. Our General Terms of Use for Downloads are valid (<http://phoenixcontact.com/download>)



Fiber optic converter with integrated optical diagnostics, alarm contact, for PROFIBUS up to 12 Mbps, termination device with one fiber optic interface (SC-Duplex), 1300 nm, for fiberglass cable

Product Description

The PSI-MOS-PROFIB/FO... devices convert copper-based PROFIBUS interfaces to fiber optics. The integrated optical diagnostics allow permanent monitoring of the FO paths during installation and also during operation. The floating switch contact is activated when the signal output on the fiber optic paths drops to a critical level. The PSI-MOS-PROFIB/FO... E terminal devices convert a PROFIBUS interface for a FO cable. They are ideal for point-to-point connections.

Your advantages

- ✓ Connections can be plugged in using a COMBICON screw terminal block
- ✓ Can be combined with the PSI copper repeater in a modular way using DIN rail connectors
- ✓ Supply voltage and data signals routed through via DIN rail connectors
- ✓ Automatic data rate detection or fixed data rate setting via DIP switches
- ✓ Redundant power supply possible by means of optional system power supply unit
- ✓ High-quality electrical isolation between all interfaces (PROFIBUS // fiber optic ports // power supply // DIN rail connector)
- ✓ Approved for use in zone 2
- ✓ Floating switch contact for leading alarm generation in relation to critical fiber optic paths
- ✓ Integrated optical diagnostics for continuous monitoring of fiber optic paths
- ✓ Bit retiming for any cascading depth
- ✓ Suitable for all data rates up to 12 Mbps



Key Commercial Data

Packing unit	1 pc
GTIN	
GTIN	4046356174060

Technical data

Note

Utilization restriction	EMC: class A product, see manufacturer's declaration in the download area
-------------------------	---

FO converters - PSI-MOS-PROFIB/FO1300 E - 2708559

Technical data

Dimensions

Width	35 mm
Height	105 mm
Depth	106 mm

Ambient conditions

Ambient temperature (operation)	-20 °C ... 60 °C
Ambient temperature (storage/transport)	-40 °C ... 85 °C
Permissible humidity (operation)	30 % ... 95 % (non-condensing)
Altitude	≤ 5000 m (For restrictions, see the manufacturer's declaration for altitude operation)
Degree of protection	IP20
Noise immunity	EN 61000-6-2:2005

General

Bit distortion, input	± 35 % (permitted)
Bit distortion, output	< 6.25 %
Electrical isolation	VCC // RS-485
Test voltage data interface/power supply	1.5 kV _{rms} (50 Hz, 1 min.)
Electromagnetic compatibility	Conformance with EMC Directive 2014/30/EU
Noise emission	EN 55011
Net weight	187.38 g
Housing material	PA 6.6-FR
Color	green
MTBF	406 Years (Telcordia standard, 25°C temperature, 21% operating cycle (5 days a week, 8 hours a day))
	92 Years (Telcordia standard, 40°C temperature, 34.25% operating cycle (5 days a week, 12 hours a day))
MTTF	849 Years (SN 29500 standard, temperature 25°C, operating cycle 21%)
	392 Years (SN 29500 standard, temperature 40°C, operating cycle 34.25%)
	163 Years (SN 29500 standard, temperature 40°C, operating cycle 100%)

Power supply

Nominal supply voltage	24 V DC (With UL approval)
Supply voltage range	18 V DC ... 32 V DC
Max. current consumption	90 mA
Typical current consumption	55 mA (24 V DC)
	170 mA (According to UL Listed, 24 V DC)
	110 mA (According to UL Recognized, 24 V DC)
Connection method	COMBICON plug-in screw terminal block

Interfaces

Interface 1	PROFIBUS acc. to IEC 61158, RS-485 2-wire, half duplex, automatic control
-------------	---

FO converters - PSI-MOS-PROFIB/FO1300 E - 2708559

Technical data

Interfaces

Operating mode	Semi-duplex
Connection method	D-SUB-9 female connector
File format/coding	UART (11 Bit, NRZ)
Data direction switching	Automatic control
Transmission medium	Copper
Transmission length	≤ 1200 m (depending on the data rate, with shielded, twisted pair data cable)
Conductor cross section solid min.	0.2 mm ²
Conductor cross section solid max.	2.5 mm ²
Conductor cross section flexible min.	0.2 mm ²
Conductor cross section flexible max.	2.5 mm ²
Conductor cross section AWG min.	24
Conductor cross section AWG max.	14
Serial transmission speed	≤ 12 Mbps

Optical interface FO

No. of channels	1
Wavelength	1300 nm
Transmission length incl. 3 dB system reserve	25 km (With F-G 50/125 0.7 dB/km at 1300 nm)
	22 km (with F-G 62.5/125 0.8 dB/km at 1300 nm)
	45 km (With F-E 9/125 0,4 dB/km at 1300 nm)
Transmission medium	Multi-mode fiberglass
	Single-mode fiberglass
Transmission protocol	Protocol-transparent to the RS-485 interface
Connection method	SC duplex

Digital outputs

Output name	Relay output
Output description	Alarm output
Number of outputs	1
Maximum switching voltage	60 V DC
	42 V AC
Limiting continuous current	1 A

Conformance/approvals

Designation	CE
Identification	CE-compliant
Designation	EAC
Identification	EAC
Designation	ATEX
Identification	# II 3 G Ex nA nC IIC T4 Gc X
Additional text	Please follow the special installation instructions in the documentation!
Designation	UL, USA/Canada

FO converters - PSI-MOS-PROFIB/FO1300 E - 2708559

Technical data

Conformance/approvals

Identification	508 Listed
	508 Recognized
Designation	Corrosive gas test
Identification	ISA-S71.04-1985 G3 Harsh Group A

Standards and Regulations

Electromagnetic compatibility	Conformance with EMC Directive 2014/30/EU
Type of test	Vibration resistance in acc. with EN 60068-2-6/IEC 60068-2-6
Test result	5g, 10...150 Hz, 2.5 h, in XYZ direction
Type of test	Shock in acc. with EN 60068-2-27/IEC 60068-2-27
Test result	15g, 11 ms period, half-sine shock pulse
Noise emission	EN 55011
Noise immunity	EN 61000-6-2:2005
Free from substances that could impair the application of coating	according to P-VW 3.10.7 57 65 0 VW-AUDI-Seat central standard
Connection in acc. with standard	CUL
Standards/regulations	EN 61000-4-2
Contact discharge	± 6 kV
Standards/regulations	EN 61000-4-3
	EN 61000-4-4
Comments	Criterion B
Standards/regulations	EN 61000-4-5
Signal	± 1 kV
Standards/regulations	EN 55011
	EN 61000-4-6

Environmental Product Compliance

REACH SVHC	Lead 7439-92-1
China RoHS	Environmentally Friendly Use Period = 50 years
	For details about hazardous substances go to tab "Downloads", Category "Manufacturer's declaration"

Drawings

FO converters - PSI-MOS-PROFIB/FO1300 E - 2708559

Application drawing

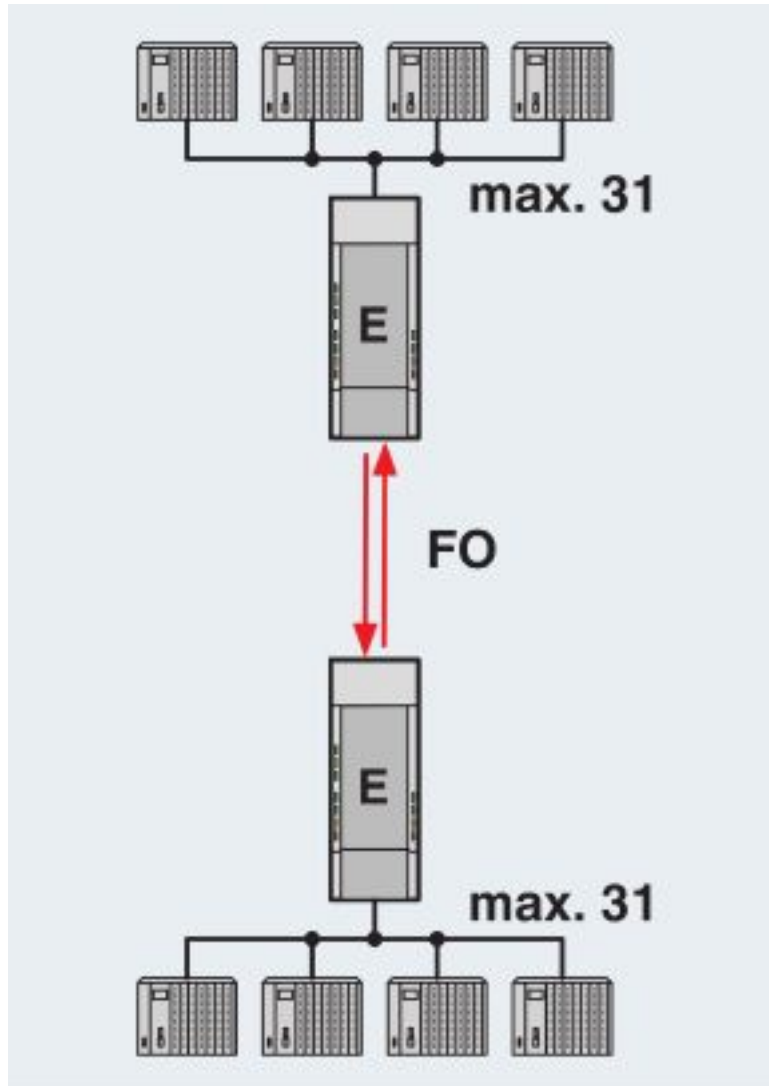

Point-to-point connection

FO converters - PSI-MOS-PROFIB/FO1300 E - 2708559

Application drawing

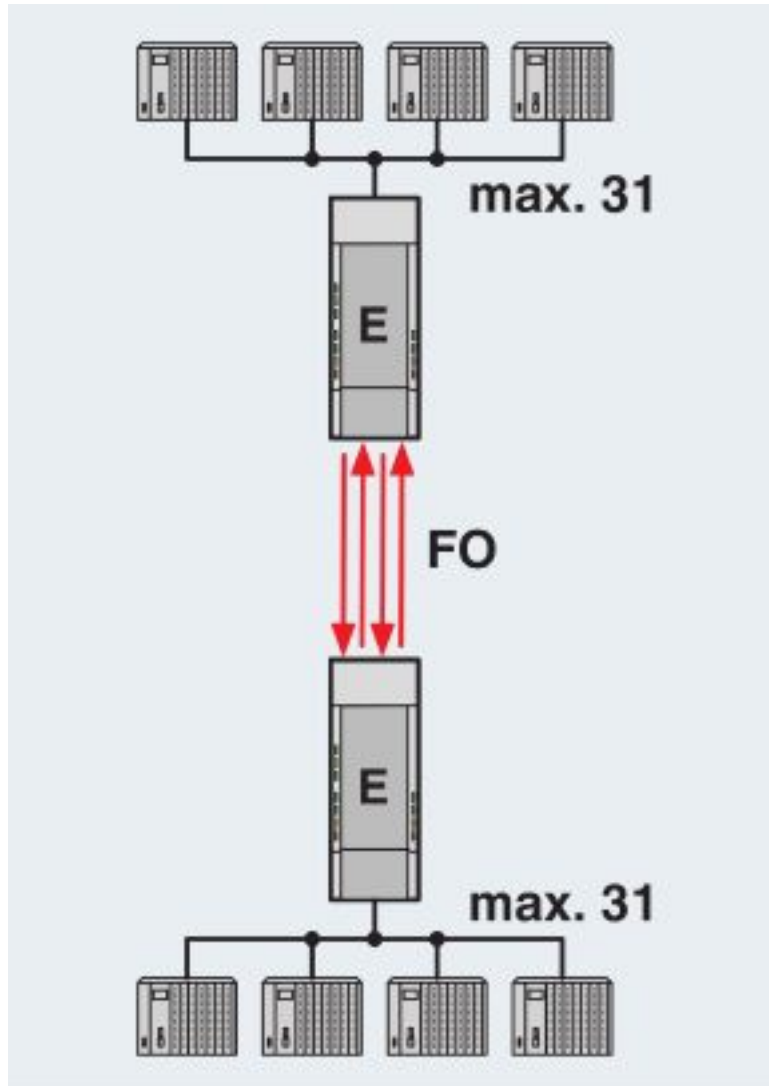

Redundant point-to-point connection

FO converters - PSI-MOS-PROFIB/FO1300 E - 2708559

Application drawing

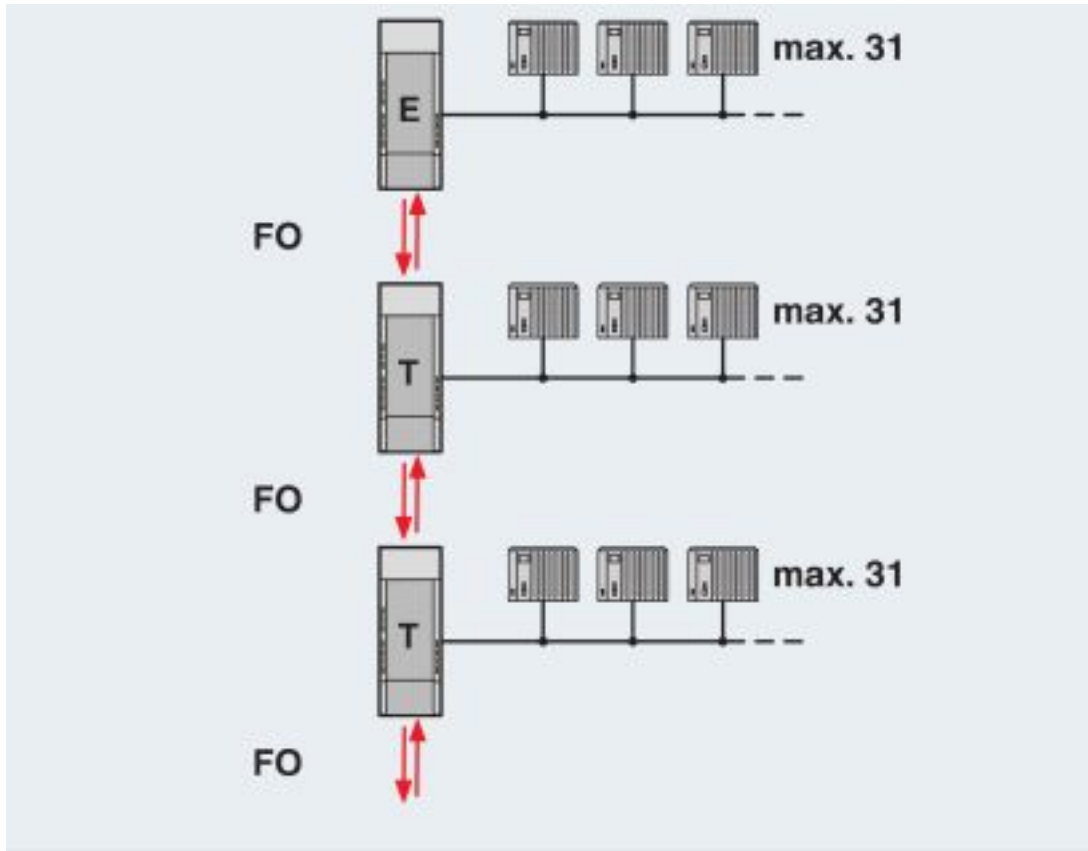

Line structure

FO converters - PSI-MOS-PROFIB/FO1300 E - 2708559

Application drawing

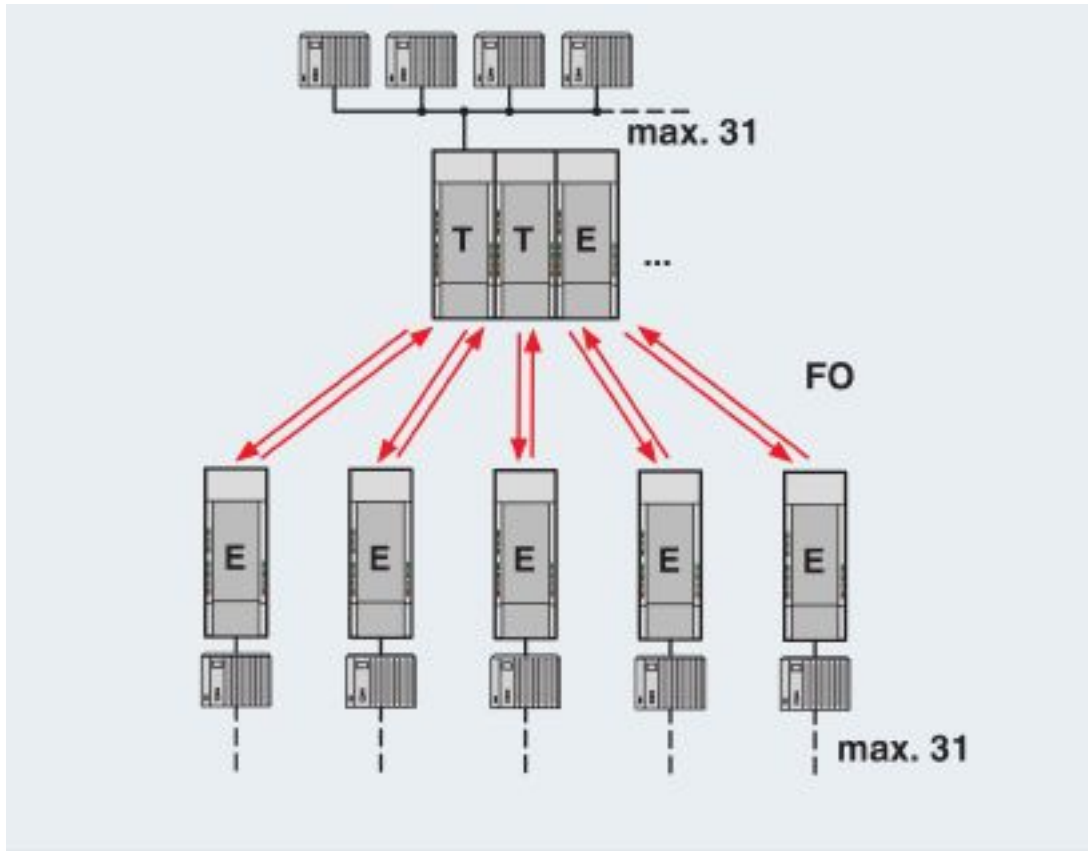

Star structure

FO converters - PSI-MOS-PROFIB/FO1300 E - 2708559

Application drawing

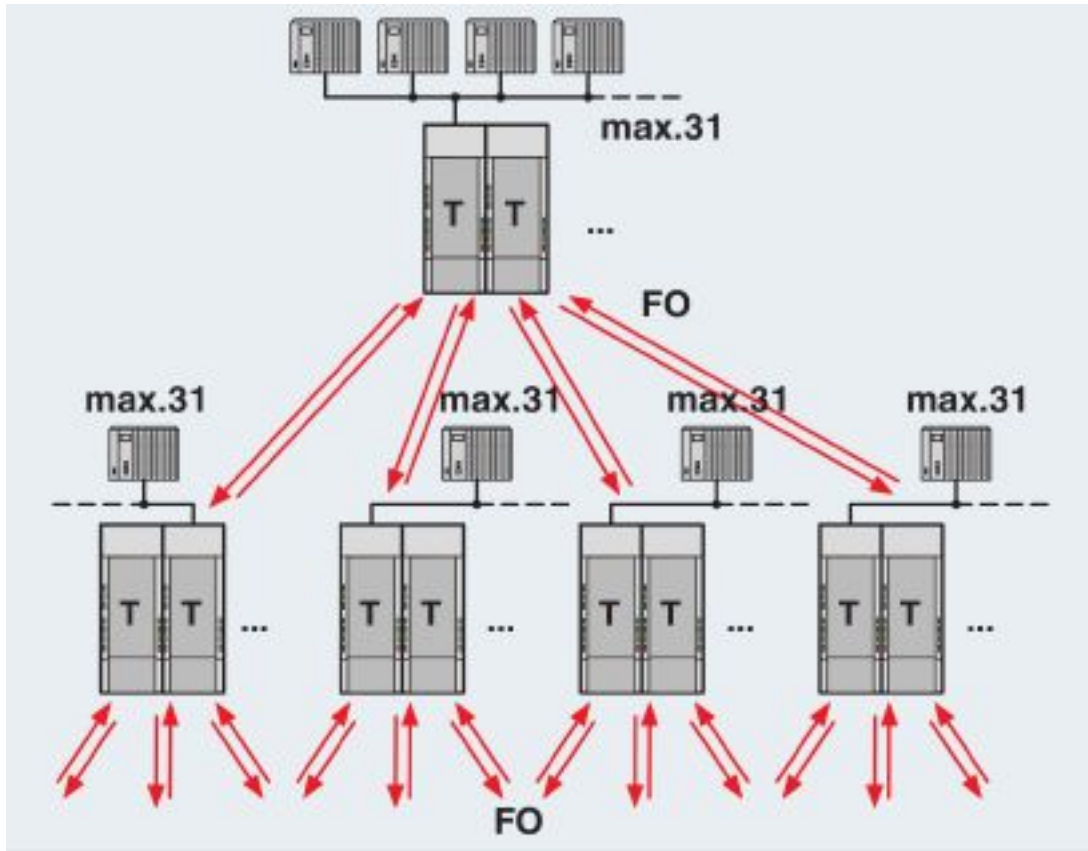

Tree structure

FO converters - PSI-MOS-PROFIB/FO1300 E - 2708559

Application drawing

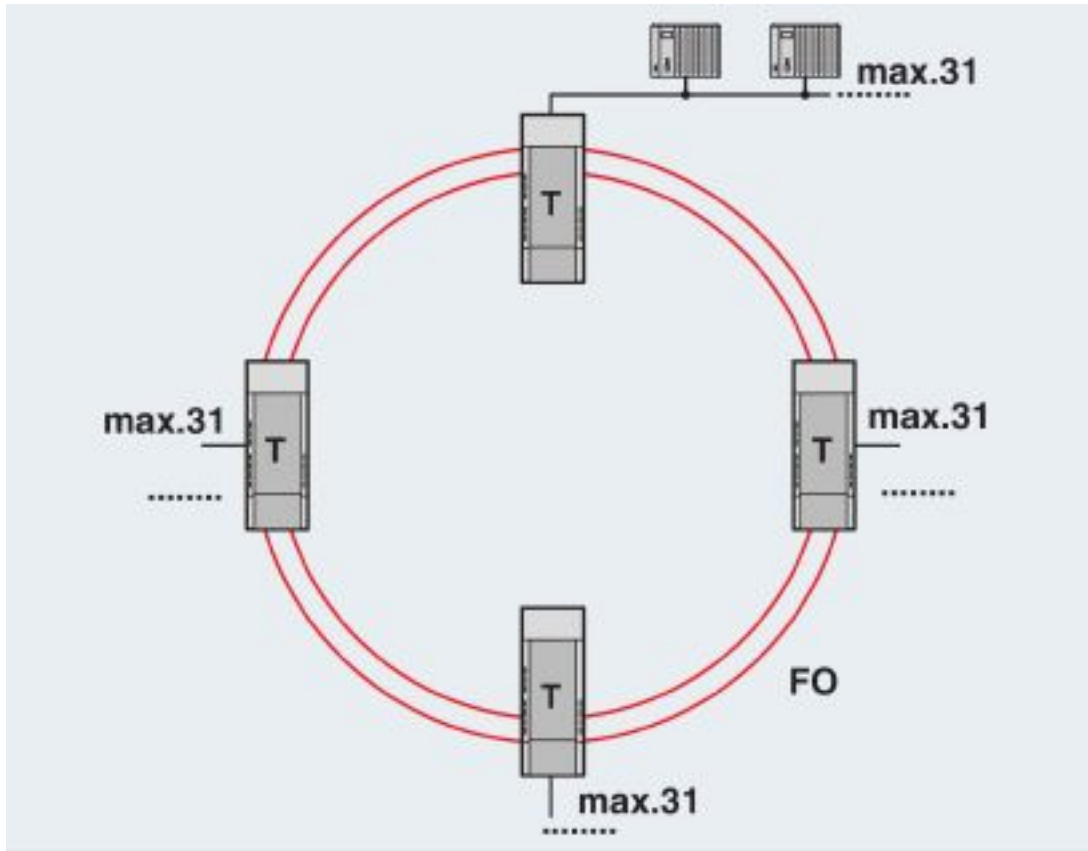

Redundant FO ring

FO converters - PSI-MOS-PROFIB/FO1300 E - 2708559

Dimensional drawing

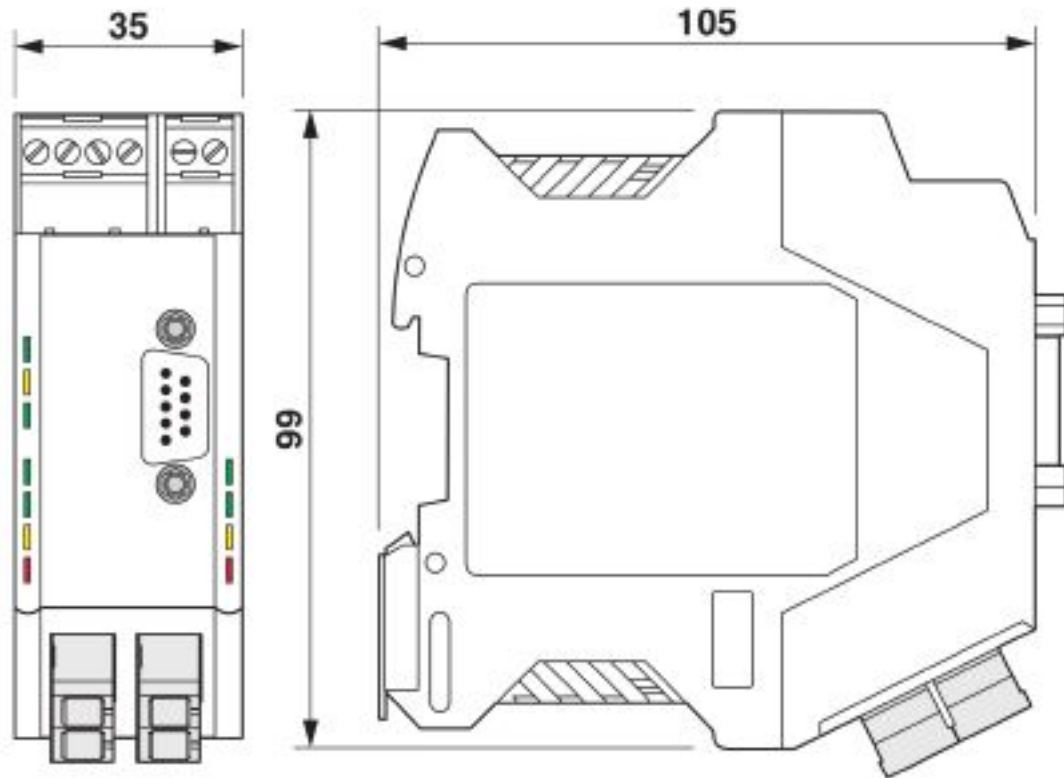

Classifications

eCl@ss

eCl@ss 10.0.1	19170132
eCl@ss 4.0	27230200
eCl@ss 4.1	27230200
eCl@ss 5.0	27230200
eCl@ss 5.1	27230200
eCl@ss 6.0	19179200
eCl@ss 7.0	19179290
eCl@ss 8.0	19179290
eCl@ss 9.0	19170114

ETIM

ETIM 2.0	EC001423
ETIM 3.0	EC001423
ETIM 4.0	EC001423

FO converters - PSI-MOS-PROFIB/FO1300 E - 2708559

Classifications

ETIM

ETIM 5.0	EC000310
ETIM 6.0	EC001467
ETIM 7.0	EC001467

UNSPSC

UNSPSC 6.01	30211506
UNSPSC 7.0901	39121008
UNSPSC 11	39121008
UNSPSC 12.01	39121008
UNSPSC 13.2	43222604
UNSPSC 18.0	43223323
UNSPSC 19.0	43223323
UNSPSC 20.0	43223323
UNSPSC 21.0	43223323

Approvals

Approvals

Approvals

UL Listed / UL Recognized / cUL Recognized / cUL Listed / EAC / EAC / cULus Recognized / cULus Listed

Ex Approvals

ATEX

Approval details

UL Listed		http://database.ul.com/cgi-bin/XYV/template/LISEXT/1FRAME/index.htm	FILE E 238705
-----------	---	---	---------------

UL Recognized		http://database.ul.com/cgi-bin/XYV/template/LISEXT/1FRAME/index.htm	FILE E 238705
---------------	---	---	---------------

cUL Recognized		http://database.ul.com/cgi-bin/XYV/template/LISEXT/1FRAME/index.htm	FILE E 238705
----------------	---	---	---------------

FO converters - PSI-MOS-PROFIB/FO1300 E - 2708559

Approvals

cUL Listed		http://database.ul.com/cgi-bin/XYV/template/LISEXT/1FRAME/index.htm	FILE E 238705
------------	--	---	---------------

EAC		EAC-Zulassung
-----	--	---------------

EAC		RU *- DE.A*30.B.01735
-----	--	--------------------------

cULus Recognized		
------------------	--	--

cULus Listed		
--------------	--	--

Accessories

Accessories

Data cable by the meter

FO cable - PSM-LWL-GDO- 50/125 - 2799432



Fiberglass cable, duplex 50/125 µm, by the meter, without connector, for outdoor installation

FO cable - PSM-LWL-GDM-RUGGED- 50/125 - 2799322



Fiber glass cable, duplex 50 µm/125 µm, by the meter, without male connector, for installation in stationary systems and machines

Data cable preassembled

FO converters - PSI-MOS-PROFIB/FO1300 E - 2708559

Accessories

FO patch cable - FL MM PATCH 1,0 LC-SC - 2989161



Assembled FO cable, break out cable, multimode fiberglass 50/125 µm (OM2), connector: LC/SC duplex, degree of protection: IP20, for installation in cable ducts or control cabinets, length: 1 m

FO patch cable - FL MM PATCH 2,0 LC-SC - 2989268



Assembled FO cable, break out cable, multimode fiberglass 50/125 µm (OM2), connector: LC/SC duplex, degree of protection: IP20, for installation in cable ducts or control cabinets, length: 2 m

FO patch cable - FL MM PATCH 5,0 LC-SC - 2901800



Assembled FO cable, break out cable, multimode fiberglass 50/125 µm (OM2), connector: LC/SC duplex, degree of protection: IP20, for installation in cable ducts or control cabinets, length: 5 m

FO patch cable - FL MM PATCH 1,0 SC-SC - 2901805



Assembled FO cable, break out cable, multimode fiberglass 50/125 µm (OM2), connector: SC duplex/SC duplex, degree of protection: IP20, for installation in cable ducts or control cabinets, length: 1 m

FO patch cable - FL MM PATCH 2,0 SC-SC - 2901807



Assembled FO cable, break out cable, multimode fiberglass 50/125 µm (OM2), connector: SC duplex/SC duplex, degree of protection: IP20, for installation in cable ducts or control cabinets, length: 2 m

FO converters - PSI-MOS-PROFIB/FO1300 E - 2708559

Accessories

FO patch cable - FL MM PATCH 5,0 SC-SC - 2901808



Assembled FO cable, break out cable, multimode fiberglass 50/125 μm (OM2), connector: SC duplex/SC duplex, degree of protection: IP20, for installation in cable ducts or control cabinets, length: 5 m

FO patch cable - FL MM PATCH 1,0 SC-ST - 2901809



Assembled FO cable, break out cable, multimode fiberglass 50/125 μm (OM2), connector: SC duplex/B-FOC(ST), degree of protection: IP20, for installation in cable ducts or control cabinets, length: 1 m

FO patch cable - FL MM PATCH 2,0 SC-ST - 2901810



Assembled FO cable, break out cable, multimode fiberglass 50/125 μm (OM2), connector: SC duplex/B-FOC(ST), degree of protection: IP20, for installation in cable ducts or control cabinets, length: 2 m

FO patch cable - FL MM PATCH 5,0 SC-ST - 2901811



Assembled FO cable, break out cable, multimode fiberglass 50/125 μm (OM2), connector: SC duplex/B-FOC(ST®), degree of protection: IP20, for installation in cable ducts or control cabinets, length: 5 m

FO patch cable - FL MM PATCH 1,0 SC-SCRJ - 2901812



Assembled FO cable, break out cable, multimode fiberglass 50/125 μm (OM2), connector: SC duplex/SC-RJ, degree of protection: IP20, for installation in cable ducts or control cabinets, length: 1 m

FO converters - PSI-MOS-PROFIB/FO1300 E - 2708559

Accessories

FO patch cable - FL MM PATCH 2,0 SC-SCRJ - 2901813



Assembled FO cable, break out cable, multimode fiberglass 50/125 μm (OM2), connector: SC duplex/SC-RJ, degree of protection: IP20, for installation in cable ducts or control cabinets, length: 2 m

FO patch cable - FL MM PATCH 5,0 SC-SCRJ - 2901814



Assembled FO cable, break out cable, multimode fiberglass 50/125 μm (OM2), connector: SC duplex/SC-RJ, degree of protection: IP20, for installation in cable ducts or control cabinets, length: 5 m

FO patch cable - FL SM PATCH 1,0 LC-SC - 2989190



Assembled fiber optic cable, break-out cable, fiberglass single mode 9/125 μm (OS2, Low Water Peak Fiber) connector: LC/SC duplex, degree of protection: IP20, for installation in cable ducts or control cabinets, length: 1 m

FO patch cable - FL SM PATCH 2,0 LC-SC - 2989297



Assembled fiber optic cable, break-out cable, fiberglass single mode 9/125 μm (OS2, Low Water Peak Fiber) connector: LC/SC duplex, degree of protection: IP20, for installation in cable ducts or control cabinets, length: 2 m

FO patch cable - FL SM PATCH 5,0 LC-SC - 2901827



Assembled fiber optic cable, break-out cable, fiberglass single mode 9/125 μm (OS2, Low Water Peak Fiber) connector: LC/SC duplex, degree of protection: IP20, for installation in cable ducts or control cabinets, length: 5 m

FO converters - PSI-MOS-PROFIB/FO1300 E - 2708559

Accessories

FO patch cable - FL SM PATCH 1,0 SC-SC - 2901829



Assembled fiber optic cable, break-out cable, fiberglass single mode 9/125 μm (OS2, Low Water Peak Fiber)
connector: SC duplex/SC duplex, degree of protection: IP20, for installation in cable ducts or control cabinets, length:
1 m

FO patch cable - FL SM PATCH 2,0 SC-SC - 2901830



Assembled fiber optic cable, break-out cable, fiberglass single mode 9/125 μm (OS2, Low Water Peak Fiber)
connector: SC duplex/SC duplex, degree of protection: IP20, for installation in cable ducts or control cabinets, length:
2 m

FO patch cable - FL SM PATCH 5,0 SC-SC - 2901831



Assembled fiber optic cable, break-out cable, fiberglass single mode 9/125 μm (OS2, Low Water Peak Fiber)
connector: SC duplex/SC duplex, degree of protection: IP20, for installation in cable ducts or control cabinets, length:
5 m

FO patch cable - FL SM PATCH 1,0 SC-ST - 2901832



Assembled fiber optic cable, break-out cable, fiberglass single mode 9/125 μm (OS2, Low Water Peak Fiber)
connector: SC duplex/B-FOC(ST®), degree of protection: IP20, for installation in cable ducts or control cabinets,
length: 1 m

FO patch cable - FL SM PATCH 2,0 SC-ST - 2901833



Assembled fiber optic cable, break-out cable, fiberglass single mode 9/125 μm (OS2, Low Water Peak Fiber)
connector: SC duplex/B-FOC(ST®), degree of protection: IP20, for installation in cable ducts or control cabinets,
length: 2 m

FO converters - PSI-MOS-PROFIB/FO1300 E - 2708559

Accessories

FO patch cable - FL SM PATCH 5,0 SC-ST - 2901834



Assembled fiber optic cable, break-out cable, fiberglass single mode 9/125 µm (OS2, Low Water Peak Fiber) connector: SC duplex/B-FOC(ST®), degree of protection: IP20, for installation in cable ducts or control cabinets, length: 5 m

FO patch cable - FOC-GDM-RUGGED-1016/IP20/... - 2901558



Robust GOF installation cable for assembly (IP20 heads only) for installation in stationary systems and machines, aramid strain-relief elements, with individual elements made from FRNC material, halogen-free, ozone and UV resistant, with a polyurethane (PUR) outer sheath

FO patch cable - FOC-GDM-RUGGED-1016/... - 1402193



rugged GOF installation cable for inner areas with highly tear-proof aramid strain-relief elements. Individual elements consist of highly flexible FRNC material. The cable is halogen-free, ozone and UV resistant and has a rugged polyurethane (PUR) outer sheath.

FO patch cable - FOC-GDO-1017/IP20/... - 2901559



Highly rugged GOF round cable (IP20 heads only) for assembly and for outdoor installation with integrated moisture barrier as well as rodent-proof scrim. Individual elements made from highly flexible FRNC material. The wire is ozone and UV resistant with a very rugged polyethylene outer sheath.

Data plug

D-SUB bus connector - SUBCON-PLUS-PROFIB/90/PG/SC - 2313708



D-SUB connector, 9-pos., male connector, cable entry < 90°, bus system: PROFIBUS DP up to 12 Mbps with PG D-SUB socket for connecting a programming device, termination resistor can be switched on via slide switch, pin assignment: 3, 5, 6, 8; screw connection terminal blocks

FO converters - PSI-MOS-PROFIB/FO1300 E - 2708559

Accessories

D-SUB bus connector - SUBCON-PLUS-PROFIB/90/PG/IDC - 2313685



D-SUB connector, 9-pos., male connector, cable entry < 90°, bus system: PROFIBUS DP up to 12 Mbps with PG D-SUB socket for connecting a programming device, termination resistor can be switched on via slide switch, pin assignment: 3, 5, 6, 8; IDC terminal block connection

D-SUB bus connector - SUBCON-PLUS-PROFIB/AX/M12 - 2902321



D-SUB plug, 9-pos., pin, assignment: 3, 5, 6, 8; two M12 cable glands (B-coded) under 180° (axial). Bus system: PROFIBUS DP up to 12 Mbps. Termination resistor via separate M12 terminator.

D-SUB bus connector - SUBCON-PLUS-PROFIB/90X/M12 - 2902729



D-SUB plug, 9-pos., pin, assignment: 3, 5, 6, 8; two M12 cable glands (B-coded) under 90°. Bus system: PROFIBUS DP up to 12 Mbps. Termination resistor via separate M12 terminator. Long version; S7-compatible.

D-SUB bus connector - SUBCON-PLUS-PROFIB/90/M12 - 2902318



D-SUB plug, 9-pos., pin, assignment: 3, 5, 6, 8; two M12 cable glands (B-coded) under 90°. Bus system: PROFIBUS DP up to 12 Mbps. Termination resistor via separate M12 terminator.

D-SUB bus connector - SUBCON-PLUS-PROFIB/35/M12 - 2902320



D-SUB plug, 9-pos., pin, assignment: 3, 5, 6, 8; two M12 cable glands (B-coded) under 35°. Bus system: PROFIBUS DP up to 12 Mbps. Termination resistor via separate M12 terminator.

Interface converter

FO converters - PSI-MOS-PROFIB/FO1300 E - 2708559

Accessories

Repeater - PSI-REP-PROFIBUS/12MB - 2708863



Modular repeater for electrical isolation and range increase for PROFIBUS up to 12 Mbps, 4-way isolation, rail-mountable, supply 24 V DC

Terminal resistor

Termination resistor - PSI-TERMINATOR-PB-TBUS - 2702636



Active termination resistor for PROFIBUS and RS-485 bus systems, redundant power supply, routing of the supply voltage via DIN rail connector, electrical isolation, switchable termination, integrated programming interface

Phoenix Contact 2020 © - all rights reserved
<http://www.phoenixcontact.com>

PHOENIX CONTACT GmbH & Co. KG
Flachsmarktstr. 8
32825 Blomberg
Germany
Tel. +49 5235 300
Fax +49 5235 3 41200
<http://www.phoenixcontact.com>

Mouser Electronics

Authorized Distributor

Click to View Pricing, Inventory, Delivery & Lifecycle Information:

[Phoenix Contact:](#)

[2708559](#)