

# Contact insert - HC-D 64-I-CT-M - 1584431

Please be informed that the data shown in this PDF Document is generated from our Online Catalog. Please find the complete data in the user's documentation. Our General Terms of Use for Downloads are valid (<http://phoenixcontact.com/download>)



HEAVYCON male insert, D64 series, 64-pos., crimp connection

## Your advantages

- Can be used in rail vehicles, satisfy DIN EN 45545-2 with requirement sets R22, R23, and R24 in hazard levels HL1, HL2, and HL3.
- For fast coding with plastic profile (Order No. 1410916, type CP-HC-S)



## Key Commercial Data

Packing unit	1 pc
GTIN	
GTIN	4046356142694

## Technical data

### General

Note	For HC-D64 housing, crimp contacts CK1,6-ED (crimp contacts not included in scope of supply)
	Connectors may be operated only when there is no load/voltage.
	It is imperative that guide pins (HC-CST) and sockets (HC-CBU) are used to prevent tip collision due to misalignment.
	This product replaces 1679498 HC-D 64-ESTC-R
Connection method	Crimp connection
Torque	0.8 Nm ... 1.2 Nm (PE connection)
	0.5 Nm ... 0.8 Nm (Mounting screws for mounting in the HEAVYCON housing)
Number of connections per position	1
Degree of pollution	3
Overvoltage category	III
Number of positions	64+PE
Insertion/withdrawal cycles	≥ 500

# Contact insert - HC-D 64-I-CT-M - 1584431

## Technical data

### General

Size	B24
	B48
Conductor cross section	0.14 mm <sup>2</sup> ... 2.5 mm <sup>2</sup>
Connection cross section AWG	26 ... 14
Stripping length of the individual wire	8 mm (0.14 ... 1.5 mm <sup>2</sup> )
	6 mm (2.5 mm <sup>2</sup> )
Assembly instructions	To ensure correct use, installation in housing with IP54 protection or better is required

### Ambient conditions

Ambient temperature (operation)	-40 °C ... 125 °C (including heating up of contacts)
---------------------------------	--

### Material data

Contact material	Copper alloy
Contact surface material	Ag (alternatively Au)
Contact carrier material	PC
Standards/regulations	PC: Fire protection in rail vehicles - requirement sets R22, R23, and R24 acc. to DIN EN 45545-2 (Risk level HL1 - HL3)

### Electrical characteristics

Rated voltage (III/3)	250 V
Rated surge voltage	4 kV
Rated current	10 A

### Standards and Regulations

Constructional and testing regulations	DIN VDE 0627/86
	DIN VDE 0110/02.79
	DIN VDE 0110-1/04.97
	IEC 60664-1, DIN IEC 60512
	IEC 60352
Flammability rating according to UL 94	V0
Standards/regulations	acc. to DIN EN 45545-2

### Environmental Product Compliance

China RoHS	Environmentally friendly use period: unlimited = EFUP-e
	No hazardous substances above threshold values

## Drawings

# Contact insert - HC-D 64-I-CT-M - 1584431

Schematic diagram

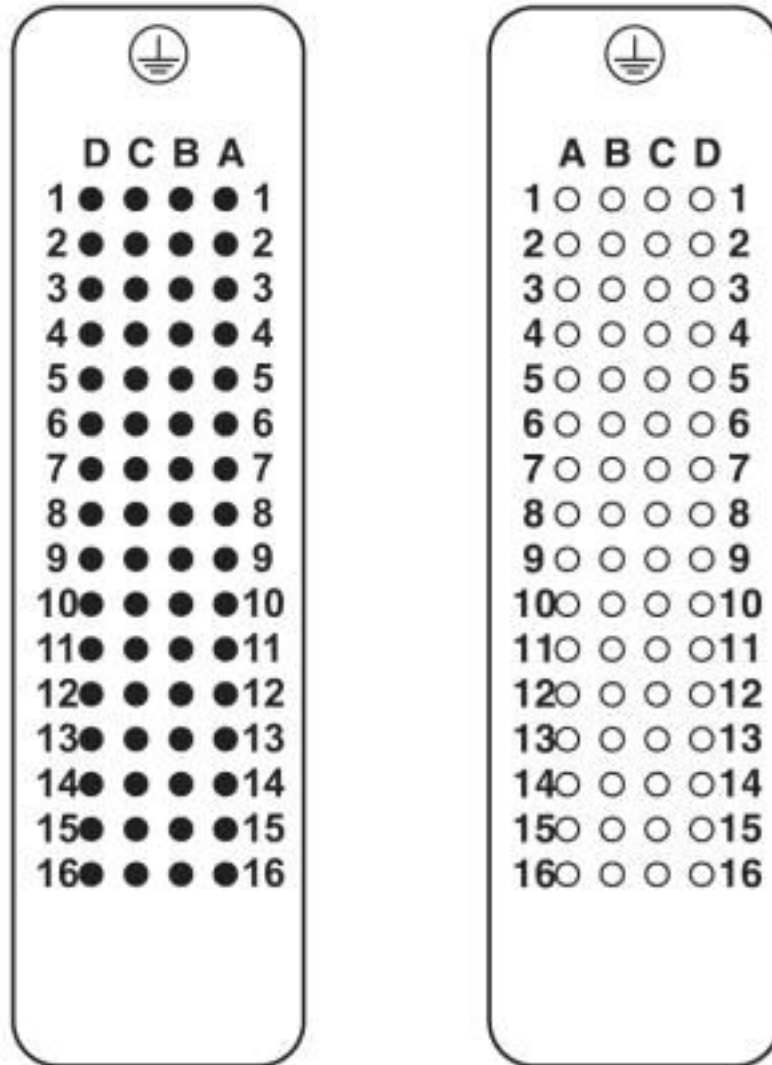

Connector pin assignment connection side: Left pin; right socket

# Contact insert - HC-D 64-I-CT-M - 1584431

Diagram

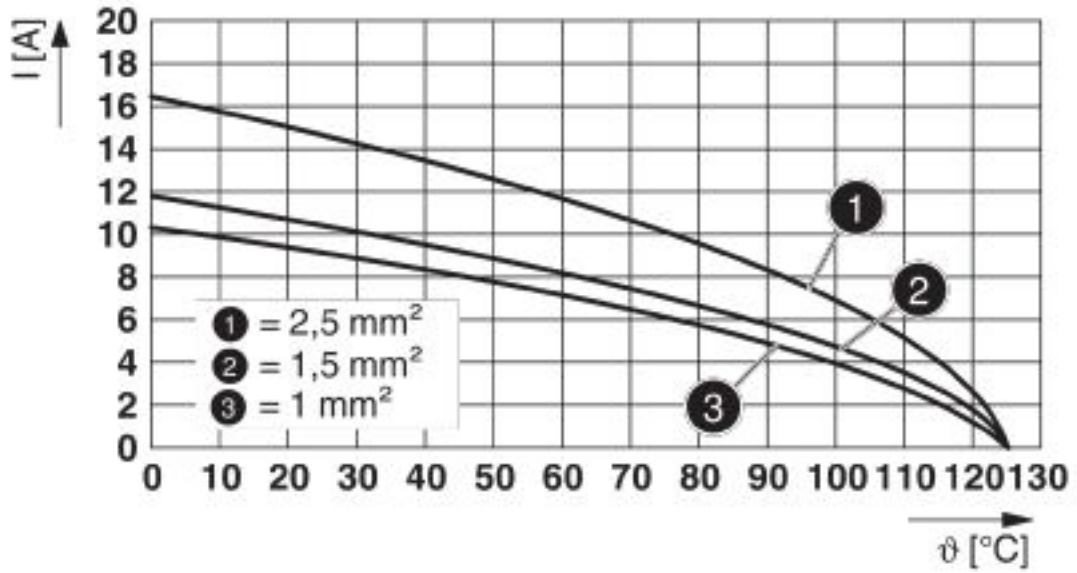

Derating diagram turned contacts

Dimensional drawing

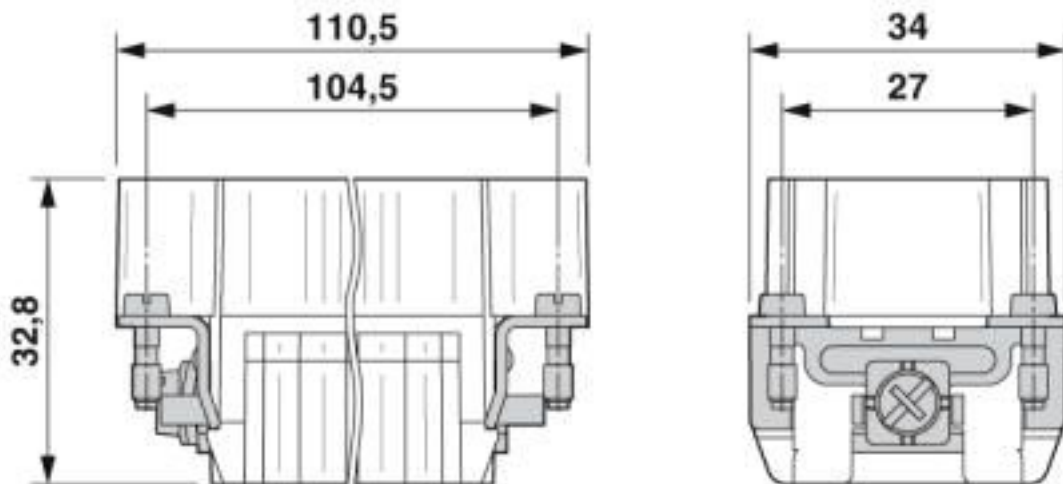

Male insert

# Contact insert - HC-D 64-I-CT-M - 1584431

Dimensional drawing

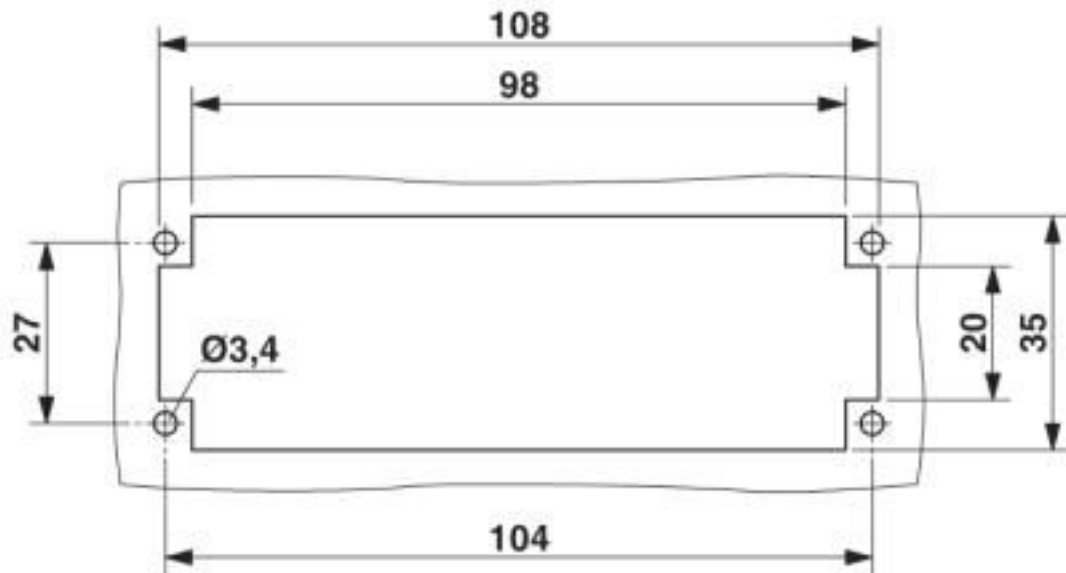

Mounting cutout when used without housing

## Classifications

### eCl@ss

eCl@ss 10.0.1	27440205
eCl@ss 4.0	27140800
eCl@ss 4.1	27140800
eCl@ss 5.0	27143400
eCl@ss 5.1	27261200
eCl@ss 6.0	27261200
eCl@ss 7.0	27440205
eCl@ss 8.0	27440205
eCl@ss 9.0	27440205

### ETIM

ETIM 2.0	EC000438
ETIM 3.0	EC000438
ETIM 4.0	EC000438
ETIM 5.0	EC000438
ETIM 6.0	EC000438
ETIM 7.0	EC000438

### UNSPSC

UNSPSC 6.01	30211923
UNSPSC 7.0901	39121522
UNSPSC 11	39121522

# Contact insert - HC-D 64-I-CT-M - 1584431

## Classifications

### UNSPSC

UNSPSC 12.01	39121522
UNSPSC 13.2	39121522
UNSPSC 18.0	39121522
UNSPSC 19.0	39121522
UNSPSC 20.0	39121522
UNSPSC 21.0	39121522

## Approvals

### Approvals

---

Approvals

CSA / UL Recognized / EAC / DNV GL / EAC

---

### Ex Approvals

---

### Approval details

CSA		<a href="http://www.csagroup.org/services-industries/product-listing/">http://www.csagroup.org/services-industries/product-listing/</a>	13631
Nominal voltage UN		600 V	
Nominal current IN		7 A	
mm <sup>2</sup> /AWG/kcmil		14	

UL Recognized		<a href="http://database.ul.com/cgi-bin/XYV/template/LISEXT/1FRAME/index.htm">http://database.ul.com/cgi-bin/XYV/template/LISEXT/1FRAME/index.htm</a>	FILE E 118976
Nominal voltage UN		600 V	
Nominal current IN		10 A	
mm <sup>2</sup> /AWG/kcmil		14	

EAC		RU C- DE.AI30.B.01102
-----	---	--------------------------

# Contact insert - HC-D 64-I-CT-M - 1584431

## Approvals

DNV GL		<a href="https://approvalfinder.dnvgl.com/">https://approvalfinder.dnvgl.com/</a>	TAE000037S
--------	--	---	------------

EAC			RU C- DE.BL08.B.00511
-----	--	--	--------------------------

## Accessories

### Accessories

#### Assembly tool

Assembly tool - UNIFOX MT-CK 1.6/2.5 - 1089092



Assembly tool, for CK 1.6... crimp contacts for small conductor cross sections

#### Coding element

Coding element - HC-CBU - 1676860



Coding socket for coding up to 16 connectors

Coding bolt - HC-CB - 1772722



Coding pin, prevents mismatching of up to six connectors with an identical number of positions

Coding element - HC-CST - 1676857



Coding peg for coding up to 16 connectors

## Contact insert - HC-D 64-I-CT-M - 1584431

### Accessories

---

Coding profile - CP-HC-S - 1410916



Coding profile, 4 elements per star, for insertion in a coding keyway, for contact inserts HC-BB... / HC-A10-I-UT... / HC-A16-I-UT...

### Crimp contact

Crimp contact - CK1,6-ED-0,37ST AG - 1663336



Turned 1.6 crimp contact, individual male contact, core diameter 0.14 to 0.37 mm<sup>2</sup>, silver-plated

Crimp contact - CK1,6-ED-0,50ST AG - 1663349



Turned 1.6 crimp contact, individual male contact, core diameter 0.5 mm<sup>2</sup>, silver-plated

Crimp contact - CK1,6-ED-0,75ST AG - 1663352



Turned 1.6 crimp contact, individual male contact, core diameter 0.75 mm<sup>2</sup>, silver-plated

Crimp contact - CK1,6-ED-1,00ST AG - 1663365



Turned 1.6 crimp contact, individual male contact, core diameter 0.75 to 1.00 mm<sup>2</sup>, silver-plated



## Contact insert - HC-D 64-I-CT-M - 1584431

### Accessories

Crimp contact - CK1,6-ED-1,50ST AG - 1663378



Turned 1.6 crimp contact, individual male contact, core diameter 1.5 mm<sup>2</sup>, silver-plated

---

Crimp contact - CK1,6-ED-2,50ST AG - 1663381



Turned 1.6 crimp contact, individual male contact, core diameter 2.5 mm<sup>2</sup>, silver-plated

---

Crimp contact - CK1,6-ED-0,37ST AU - 1674901



Turned 1.6 crimp contact, individual male contact, core diameter 0.14 to 0.37 mm<sup>2</sup>, gold-plated

---

Crimp contact - CK1,6-ED-0,50ST AU - 1672453



Turned 1.6 crimp contact, individual male contact, core diameter 0.5 mm<sup>2</sup>, gold-plated

---

Crimp contact - CK1,6-ED-0,75ST AU - 1674914



Turned 1.6 crimp contact, individual male contact, core diameter 0.75 mm<sup>2</sup>, gold-plated

---

## Contact insert - HC-D 64-I-CT-M - 1584431

### Accessories

Crimp contact - CK1,6-ED-1,00ST AU - 1674888



Turned 1.6 crimp contact, individual male contact, core diameter 0.75 to 1.00 mm<sup>2</sup>, gold-plated

---

Crimp contact - CK1,6-ED-1,50ST AU - 1674875



Turned 1.6 crimp contact, individual male contact, core diameter 1.5 mm<sup>2</sup>, gold-plated

---

Crimp contact - CK1,6-ED-2,50ST AU - 1674927



Turned 1.6 crimp contact, individual male contact, core diameter 2.5 mm<sup>2</sup>, gold-plated

---

Crimp contact - CK1,6-ER-1,00ST OIC AG - 1004360



Crimp contact, contact diameter: 1.6 mm, rolled, Pin, contact material: Cu alloy, nickel-plated, contact surface: silver-plated, connection cross section: 0.34 mm<sup>2</sup> ... 1 mm<sup>2</sup> AWG 22 ... 17

---

Crimp contact - CK1,6-ER-2,50ST OIC AG - 1004365



Crimp contact, contact diameter: 1.6 mm, rolled, Pin, contact material: Cu alloy, nickel-plated, contact surface: silver-plated, connection cross section: 1.5 mm<sup>2</sup> ... 2.5 mm<sup>2</sup> AWG 16 ... 14

---

## Contact insert - HC-D 64-I-CT-M - 1584431

### Accessories

Crimp contact - CK1,6-BR-1,00ST OIC AG - 1004380



Crimp contact, contact diameter: 1.6 mm, rolled, Pin, contact material: Cu alloy, nickel-plated, contact surface: silver-plated, connection cross section: 0.34 mm<sup>2</sup> ... 1 mm<sup>2</sup> AWG 22 ... 17

Crimp contact - CK1,6-BR-2,50ST OIC AG - 1004382



Crimp contact, contact diameter: 1.6 mm, rolled, Pin, contact material: Cu alloy, nickel-plated, contact surface: silver-plated, connection cross section: 1.5 mm<sup>2</sup> ... 2.5 mm<sup>2</sup> AWG 16 ... 14

### Crimping tool

Crimping pliers - CRIMPFOX-TC 4 - 1212113



Crimping pliers, for CK 1,6-ED..., CK 2,5-ED..., CK 4,0-ED... turned contacts, 4 marked die stations, unlockable pressure lock, lateral entry, incl. positioning tool

### Docking frame

Docking frames - HC-B 24-ANDOCK - 1586141



Docking frame for racks, for contact inserts of B24 type, with four M5 flat headed screws, rack balance x/y axis +/- 1.5 mm

### Mounting material

Screw - HC-B-PES - 1604997



PE screw, for contact inserts HC-B / HC-BB / HC-DD / HC-D40 / HC-D64

## Contact insert - HC-D 64-I-CT-M - 1584431

### Accessories

PE multiplier - HC-B-3PE - 1644326



PE multiplier, for three PE connections, for HC-B (besides HC-B..E..ZZ) / HC-BB / HC-DD / HC-D40 / HC-D64 contact inserts

---

Strain relief clamp - HC-B-ZG - 1685327



Strain relief clamps contact inserts of series: B-, BB-, D 40, D 64, DD and HV, straight cable exit

---

Strain relief clamp - HC-B-ZS - 1685330



Strain relief clamps contact inserts of series: B-, BB-, D 40, D 64, DD and HV, lateral cable exit

---

### Universal tools

Contact removal tool - UNIFOX RT-CK 1.6 - 1072069



Contact removal tool, for turned and rolled CK- 1.6-... contacts

---

### Additional products

Contact insert - HC-D 64-I-CT-F - 1584444



HEAVYCON female insert, D64 series, 64-pos., crimp connection

---

---

Phoenix Contact 2020 © - all rights reserved  
<http://www.phoenixcontact.com>

PHOENIX CONTACT GmbH & Co. KG  
Flachsmarktstr. 8  
32825 Blomberg  
Germany  
Tel. +49 5235 300  
Fax +49 5235 3 41200  
<http://www.phoenixcontact.com>

# Mouser Electronics

Authorized Distributor

Click to View Pricing, Inventory, Delivery & Lifecycle Information:

[Phoenix Contact:](#)

[1584431](#)